

GENTLE ASSOCIAHEDRA

Y. PALU
Univ. Amiens

V. PILAUD
CNRS & LIX,
École Polytechnique

P.-G. PLAMONDON
Univ. Orsay

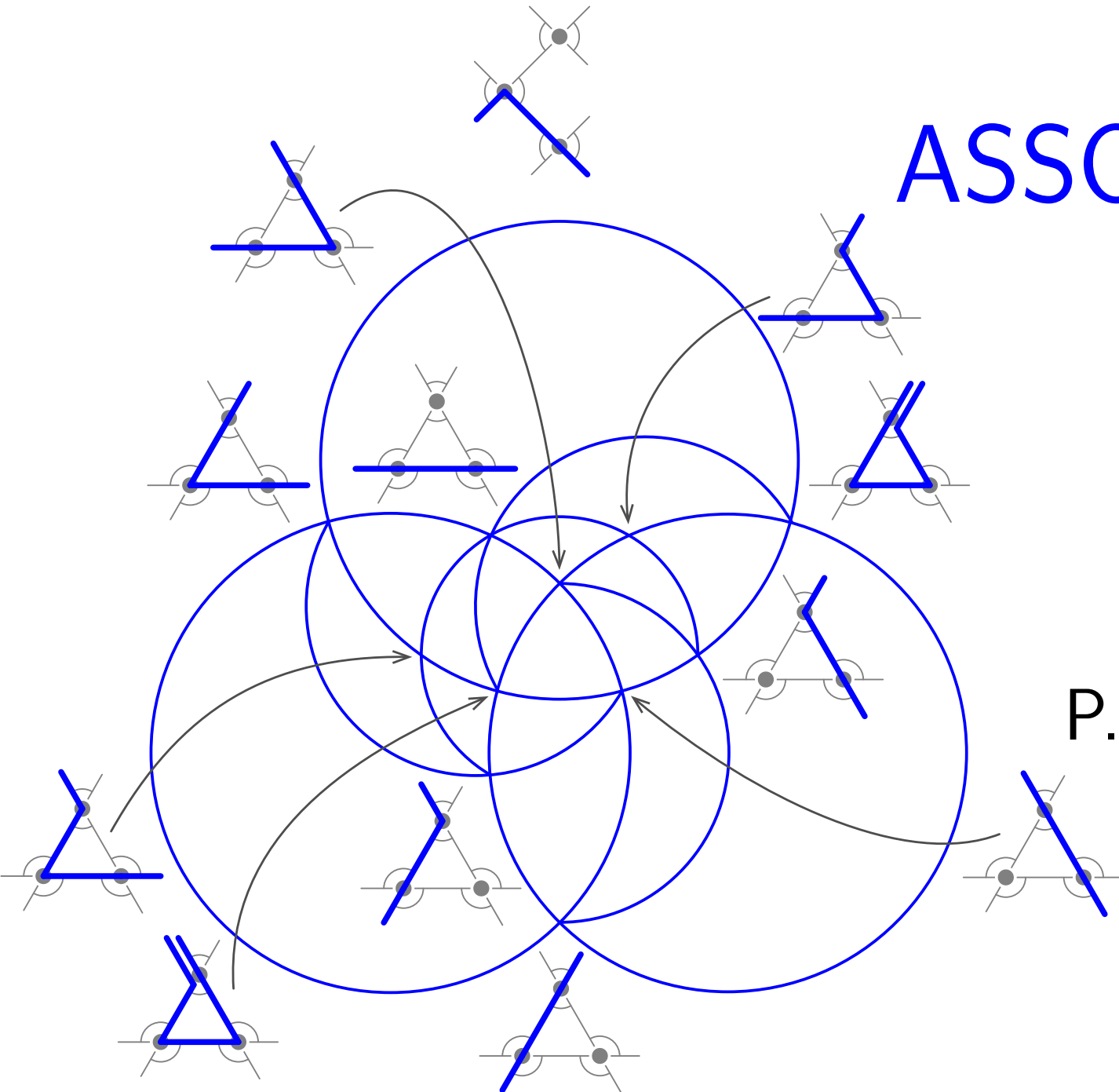

NON-KISSING COMPLEX

QUIVERS

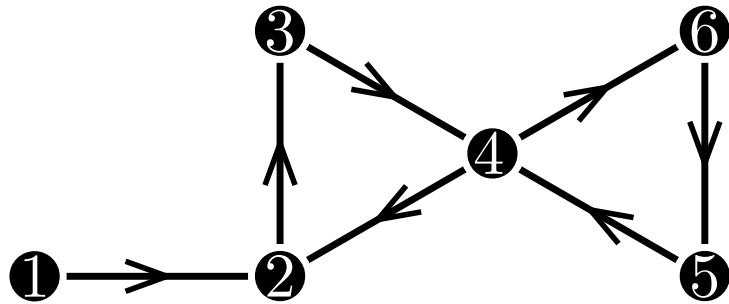

quiver = oriented graph
(loops and multiple edges allowed)

$$Q = (Q_0, Q_1, s, t)$$

Q_0 = vertices

Q_1 = edges

$s, t : Q_1 \rightarrow Q_0$ source and target maps

QUIVERS

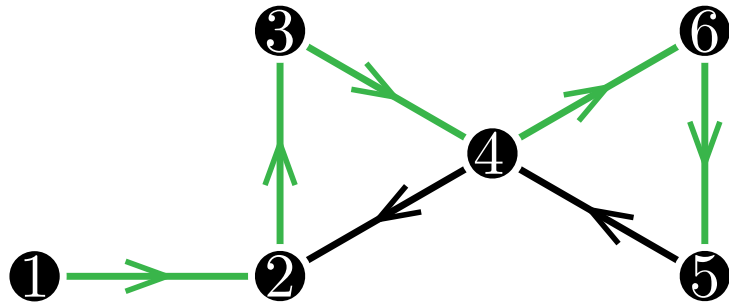

quiver = oriented graph
(loops and multiple edges allowed)

$$Q = (Q_0, Q_1, s, t)$$

Q_0 = vertices

Q_1 = edges

$s, t : Q_1 \rightarrow Q_0$ source and target maps

path = $\alpha_1 \dots \alpha_\ell$ with $\alpha_k \in Q_1$ and $t(\alpha_k) = s(\alpha_{k+1})$

path algebra $\mathbb{K}Q = \langle e_\pi \mid \pi \text{ path of } Q \rangle$ with concatenation product

$$e_{\alpha_1 \dots \alpha_\ell} \cdot e_{\beta_1 \dots \beta_k} = \begin{cases} e_{\alpha_1 \dots \alpha_\ell \beta_1 \dots \beta_k} & \text{if } t(\alpha_\ell) = s(\beta_1) \\ 0 & \text{otherwise} \end{cases}$$

QUIVERS

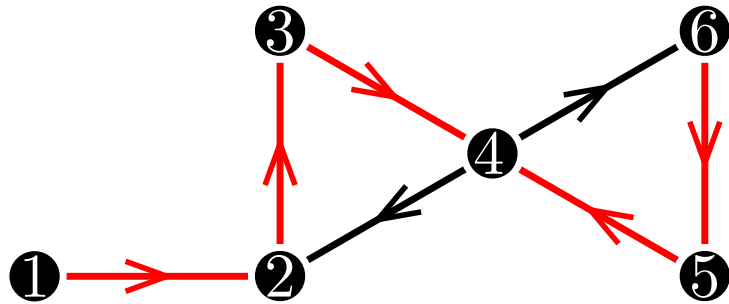

quiver = oriented graph
(loops and multiple edges allowed)

$$Q = (Q_0, Q_1, s, t)$$

Q_0 = vertices

Q_1 = edges

$s, t : Q_1 \rightarrow Q_0$ source and target maps

path = $\alpha_1 \dots \alpha_\ell$ with $\alpha_k \in Q_1$ and $t(\alpha_k) = s(\alpha_{k+1})$

path algebra $\mathbb{K}Q = \langle e_\pi \mid \pi \text{ path of } Q \rangle$ with concatenation product

$$e_{\alpha_1 \dots \alpha_\ell} \cdot e_{\beta_1 \dots \beta_k} = \begin{cases} e_{\alpha_1 \dots \alpha_\ell \beta_1 \dots \beta_k} & \text{if } t(\alpha_\ell) = s(\beta_1) \\ 0 & \text{otherwise} \end{cases}$$

QUIVERS

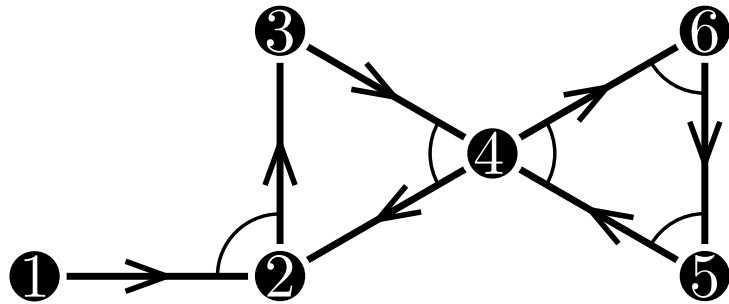

quiver = oriented graph
(loops and multiple edges allowed)

$$Q = (Q_0, Q_1, s, t)$$

Q_0 = vertices

Q_1 = edges

$s, t : Q_1 \rightarrow Q_0$ source and target maps

path = $\alpha_1 \dots \alpha_\ell$ with $\alpha_k \in Q_1$ and $t(\alpha_k) = s(\alpha_{k+1})$

path algebra $\mathbb{K}Q = \langle e_\pi \mid \pi \text{ path of } Q \rangle$ with concatenation product

$$e_{\alpha_1 \dots \alpha_\ell} \cdot e_{\beta_1 \dots \beta_k} = \begin{cases} e_{\alpha_1 \dots \alpha_\ell \beta_1 \dots \beta_k} & \text{if } t(\alpha_\ell) = s(\beta_1) \\ 0 & \text{otherwise} \end{cases}$$

bound quiver = quiver with relations

$\bar{Q} = (Q, I)$ where I is an admissible ideal of $\mathbb{K}Q$.

Complicated way to say that we forbid certain paths

QUIVERS

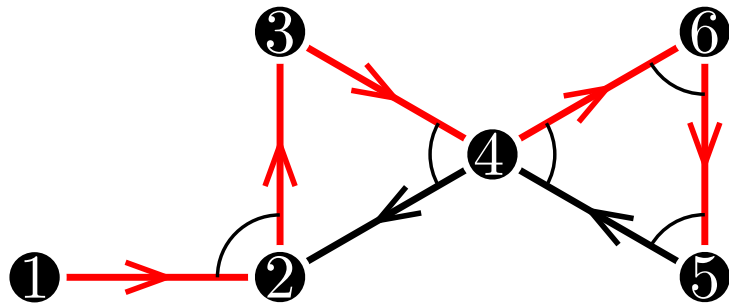

quiver = oriented graph
(loops and multiple edges allowed)

$$Q = (Q_0, Q_1, s, t)$$

Q_0 = vertices

Q_1 = edges

$s, t : Q_1 \rightarrow Q_0$ source and target maps

path = $\alpha_1 \dots \alpha_\ell$ with $\alpha_k \in Q_1$ and $t(\alpha_k) = s(\alpha_{k+1})$

path algebra $\mathbb{K}Q = \langle e_\pi \mid \pi \text{ path of } Q \rangle$ with concatenation product

$$e_{\alpha_1 \dots \alpha_\ell} \cdot e_{\beta_1 \dots \beta_k} = \begin{cases} e_{\alpha_1 \dots \alpha_\ell \beta_1 \dots \beta_k} & \text{if } t(\alpha_\ell) = s(\beta_1) \\ 0 & \text{otherwise} \end{cases}$$

bound quiver = quiver with relations

$\bar{Q} = (Q, I)$ where I is an admissible ideal of $\mathbb{K}Q$.

Complicated way to say that we forbid certain paths

QUIVERS

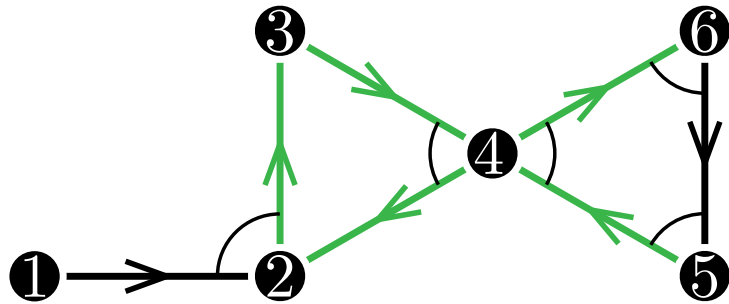

quiver = oriented graph
(loops and multiple edges allowed)

$$Q = (Q_0, Q_1, s, t)$$

Q_0 = vertices

Q_1 = edges

$s, t : Q_1 \rightarrow Q_0$ source and target maps

path = $\alpha_1 \dots \alpha_\ell$ with $\alpha_k \in Q_1$ and $t(\alpha_k) = s(\alpha_{k+1})$

path algebra $\mathbb{K}Q = \langle e_\pi \mid \pi \text{ path of } Q \rangle$ with concatenation product

$$e_{\alpha_1 \dots \alpha_\ell} \cdot e_{\beta_1 \dots \beta_k} = \begin{cases} e_{\alpha_1 \dots \alpha_\ell \beta_1 \dots \beta_k} & \text{if } t(\alpha_\ell) = s(\beta_1) \\ 0 & \text{otherwise} \end{cases}$$

bound quiver = quiver with relations

$\bar{Q} = (Q, I)$ where I is an admissible ideal of $\mathbb{K}Q$.

Complicated way to say that we forbid certain paths

QUIVERS

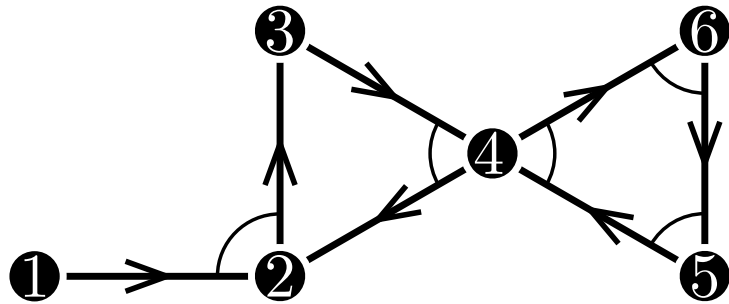

bound quiver $\bar{Q} = (Q, I)$

gentle quiver =

- forbidden paths all of length 2
- locally at each vertex, subgraph of

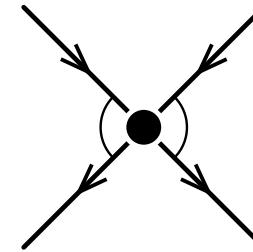

QUIVERS

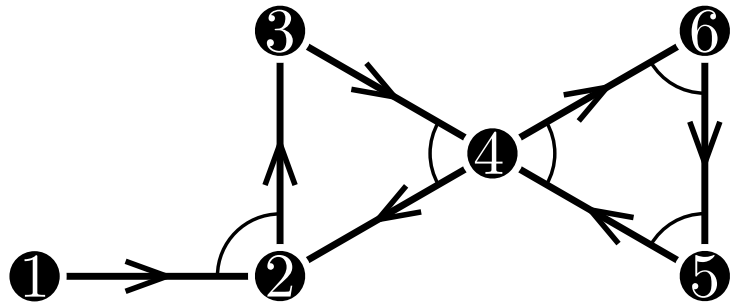

bound quiver $\bar{Q} = (Q, I)$

gentle quiver =

- forbidden paths all of length 2
- locally at each vertex, subgraph of

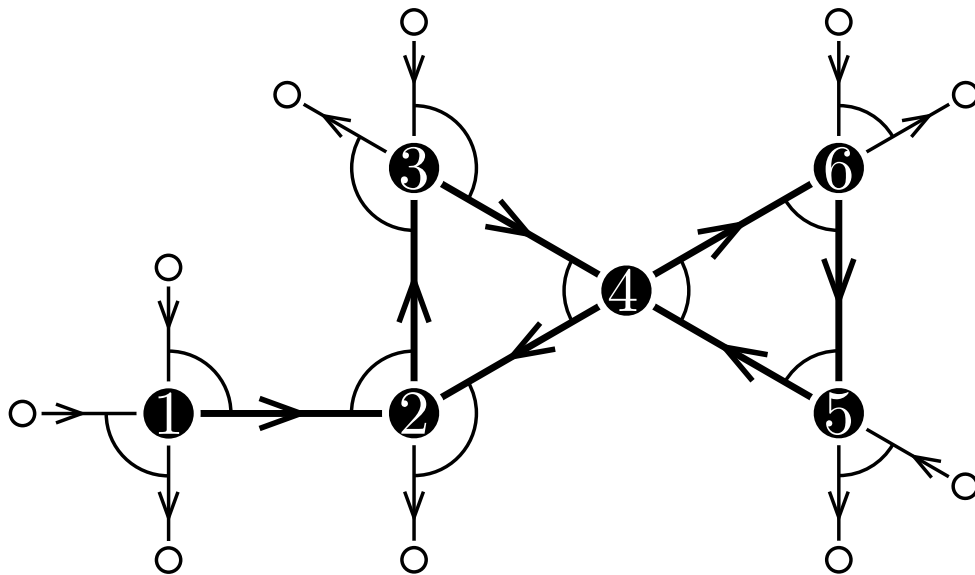
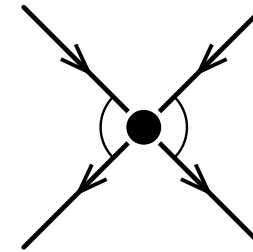

blossoming quiver \bar{Q}^* = add blossoms to complete each vertex to

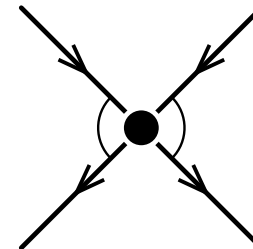

STRINGS AND WALKS

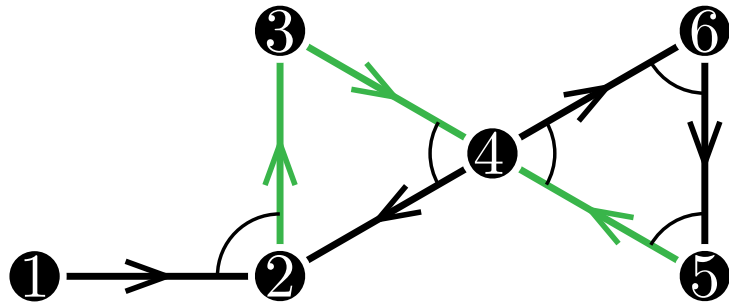

string $\sigma = \alpha_1^{\varepsilon_1} \dots \alpha_l^{\varepsilon_l}$
with $\alpha_k \in Q_1$,
 $\varepsilon_k \in \{-1, 1\}$
and $t(\alpha_k^{\varepsilon_k}) = s(\alpha_{k+1}^{\varepsilon_{k+1}})$

STRINGS AND WALKS

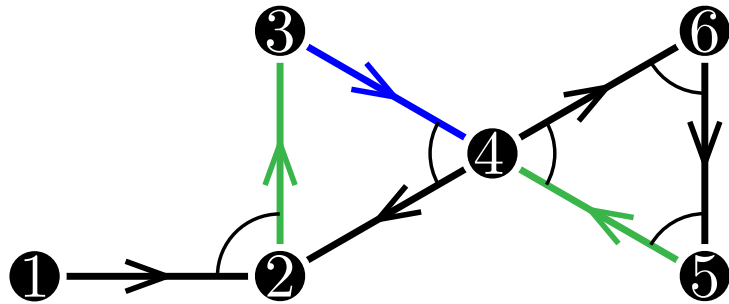

string $\sigma = \alpha_1^{\varepsilon_1} \dots \alpha_l^{\varepsilon_l}$
 with $\alpha_k \in Q_1$,
 $\varepsilon_k \in \{-1, 1\}$
 and $t(\alpha_k^{\varepsilon_k}) = s(\alpha_{k+1}^{\varepsilon_{k+1}})$

substrings of $\sigma = \{ \alpha_i^{\varepsilon_i} \dots \alpha_j^{\varepsilon_j} \mid 1 \leq i \leq j - 1 \leq k \}$

bottom substring of $\sigma =$ substring ρ of σ such that σ either ends
 or has an outgoing arrow at each endpoint of ρ

$\Sigma_{\text{bot}}(\sigma) = \{ \text{bottom substrings of } \sigma \}$

top substring of $\sigma =$ substring ρ of σ such that σ either ends
 or has an incoming arrow at each endpoint of ρ

$\Sigma_{\text{top}}(\sigma) = \{ \text{top substrings of } \sigma \}$

STRINGS AND WALKS

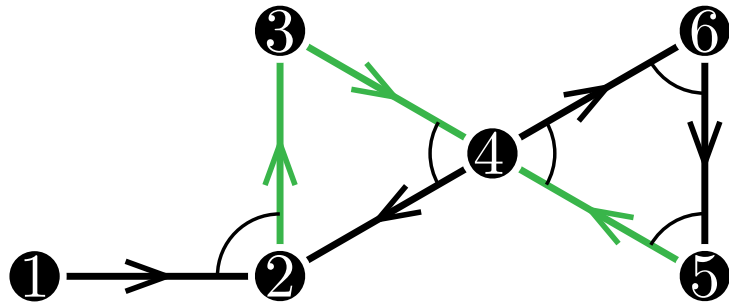

string $\sigma = \alpha_1^{\varepsilon_1} \dots \alpha_l^{\varepsilon_l}$
 with $\alpha_k \in Q_1$,
 $\varepsilon_k \in \{-1, 1\}$
 and $t(\alpha_k^{\varepsilon_k}) = s(\alpha_{k+1}^{\varepsilon_{k+1}})$

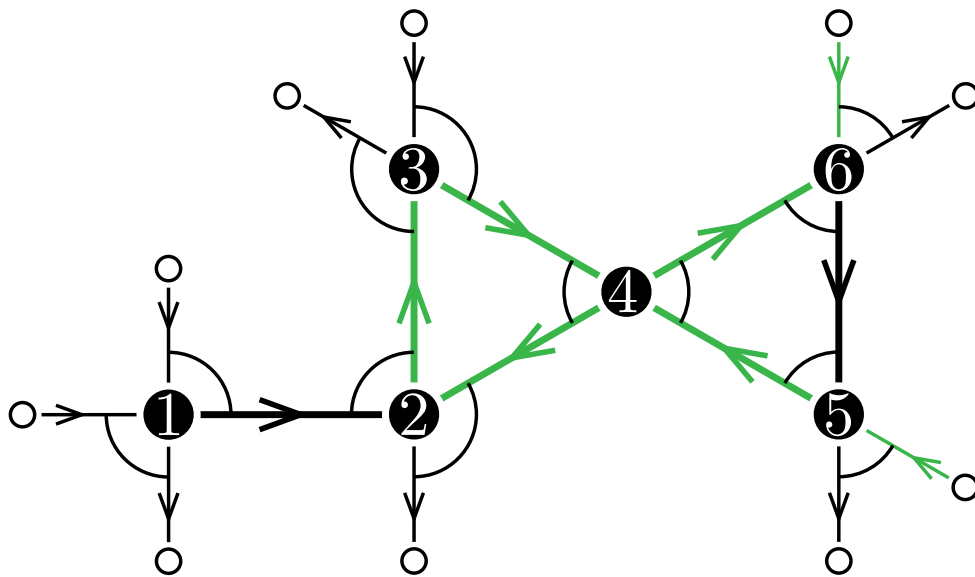

walk $\omega =$ maximal string in Q^*
 from blossoms to blossoms

STRINGS AND WALKS

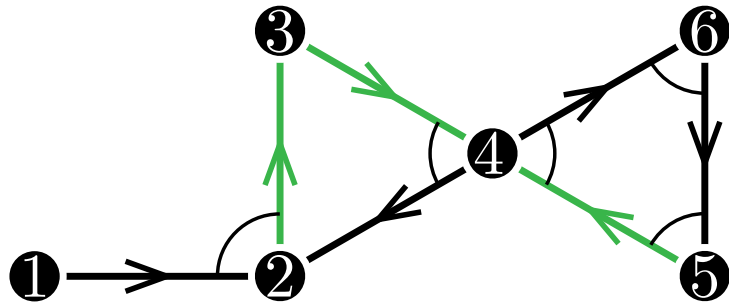

string $\sigma = \alpha_1^{\varepsilon_1} \dots \alpha_l^{\varepsilon_l}$
 with $\alpha_k \in Q_1$,
 $\varepsilon_k \in \{-1, 1\}$
 and $t(\alpha_k^{\varepsilon_k}) = s(\alpha_{k+1}^{\varepsilon_{k+1}})$

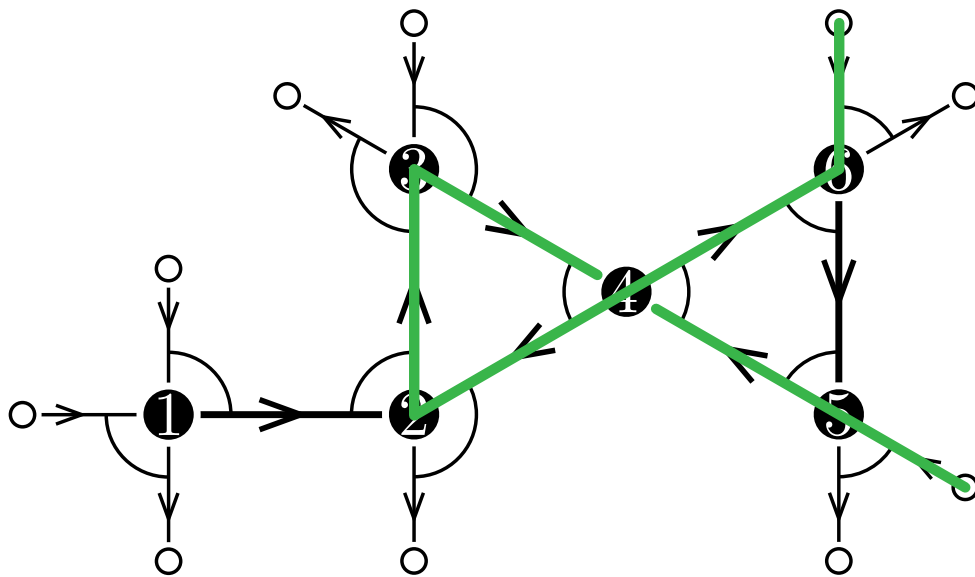

walk $\omega =$ maximal string in Q^*
 from blossoms to blossoms

STRINGS AND WALKS

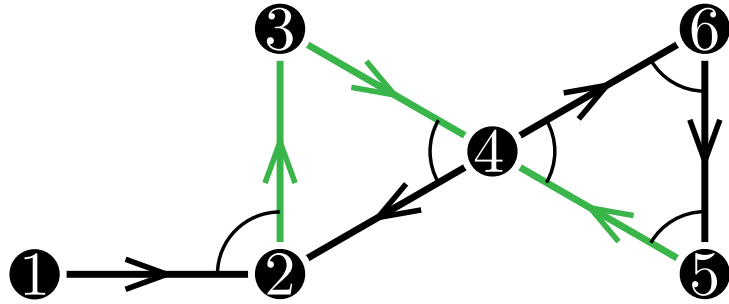

string $\sigma = \alpha_1^{\varepsilon_1} \dots \alpha_l^{\varepsilon_l}$
 with $\alpha_k \in Q_1$,
 $\varepsilon_k \in \{-1, 1\}$
 and $t(\alpha_k^{\varepsilon_k}) = s(\alpha_{k+1}^{\varepsilon_{k+1}})$

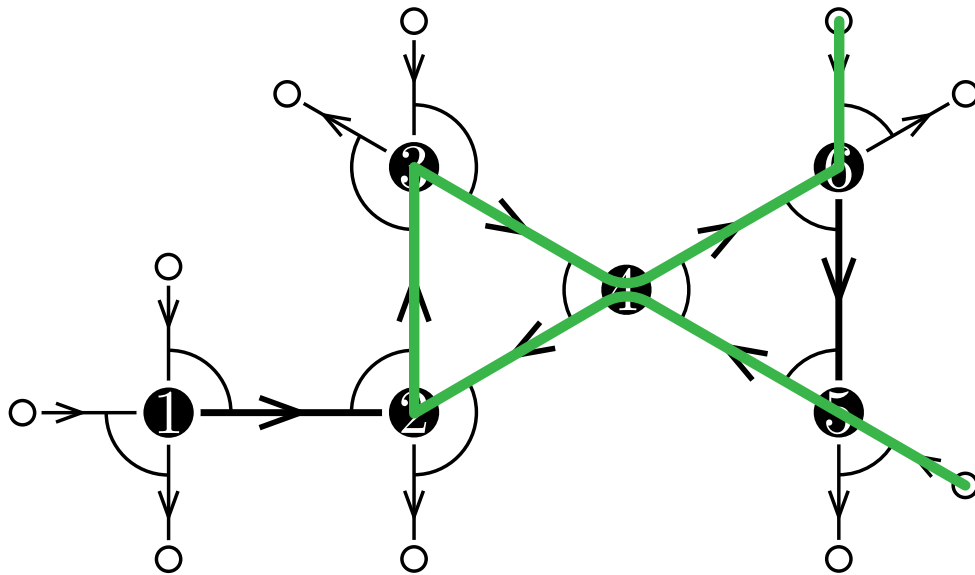

walk $\omega =$ maximal string in Q^*
 from blossoms to blossoms

NON-KISSING COMPLEX

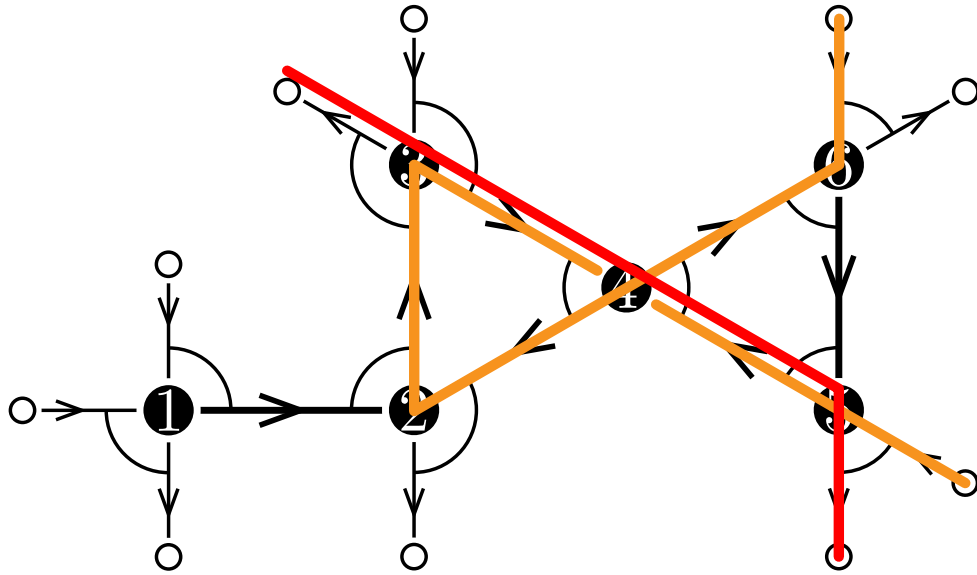

walk $\omega =$ maximal string in Q^*
from blossoms to blossoms

ω kisses ω' if $\Sigma_{\text{top}}(\omega) \cap \Sigma_{\text{bot}}(\omega') \neq \emptyset$

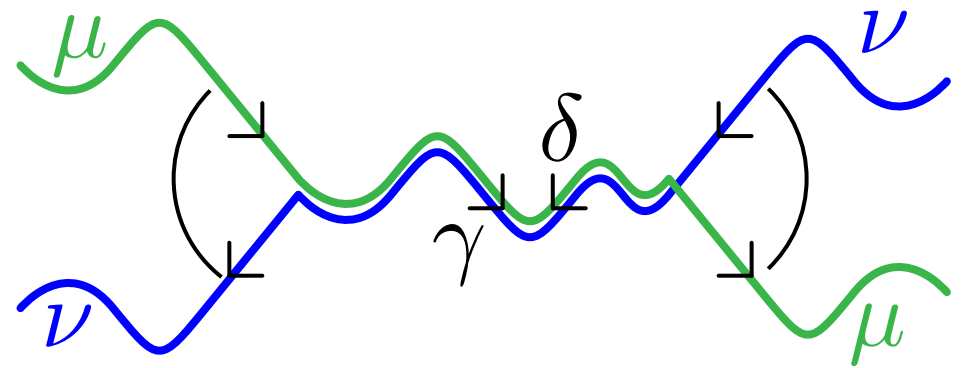
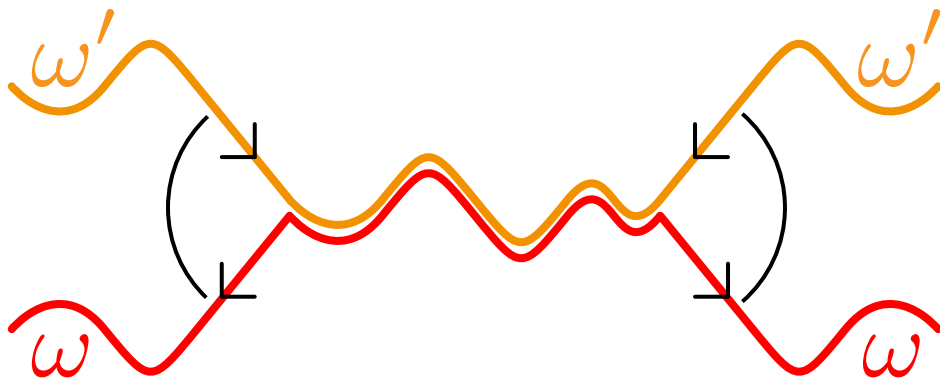

NON-KISSING COMPLEX

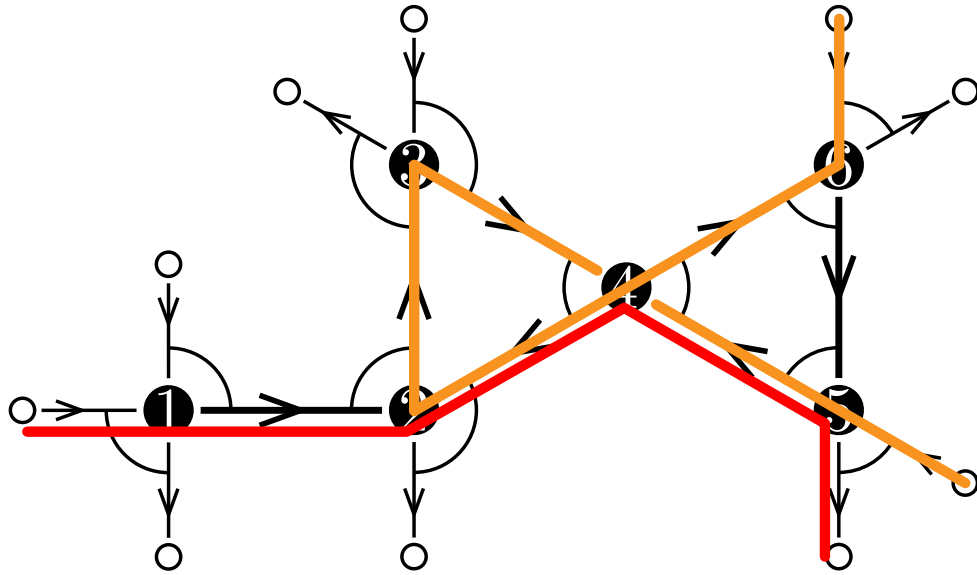

walk $\omega =$ maximal string in Q^*
from blossoms to blossoms

ω kisses ω' if $\Sigma_{\text{top}}(\omega) \cap \Sigma_{\text{bot}}(\omega') \neq \emptyset$

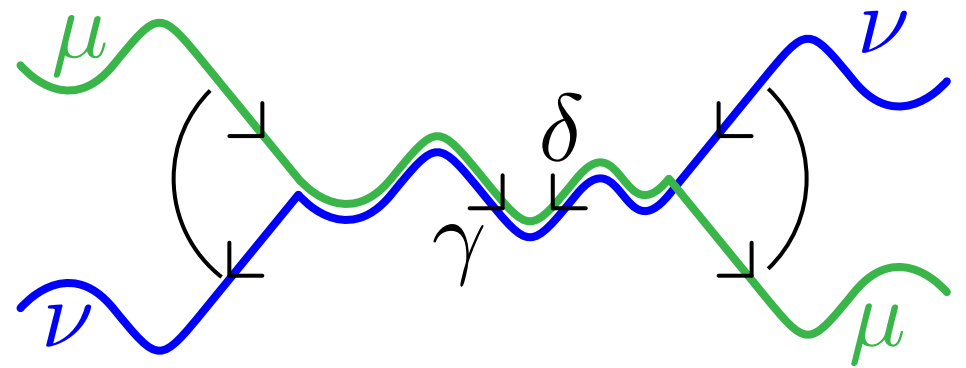
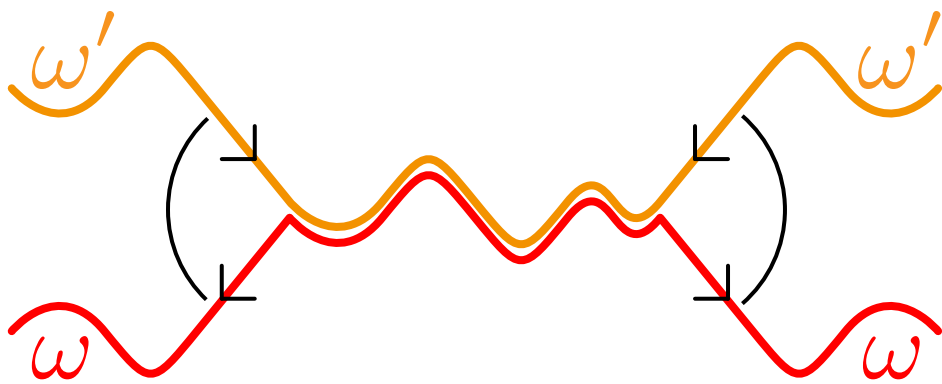

NON-KISSING COMPLEX

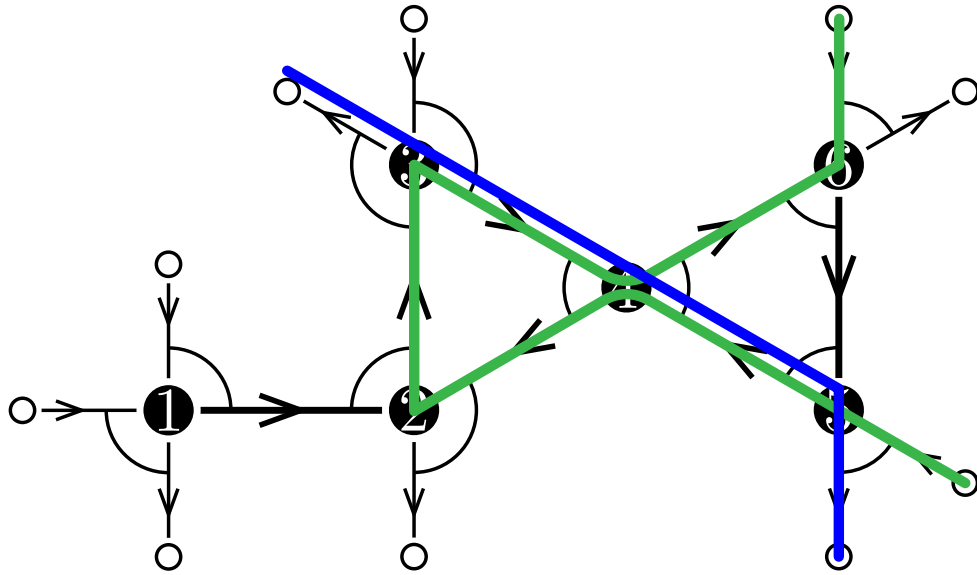

walk $\omega =$ maximal string in Q^*
from blossoms to blossoms

ω kisses ω' if $\Sigma_{\text{top}}(\omega) \cap \Sigma_{\text{bot}}(\omega') \neq \emptyset$

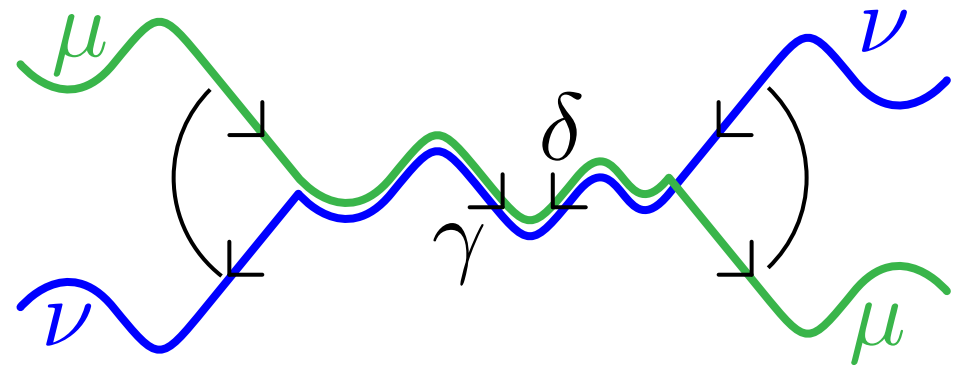
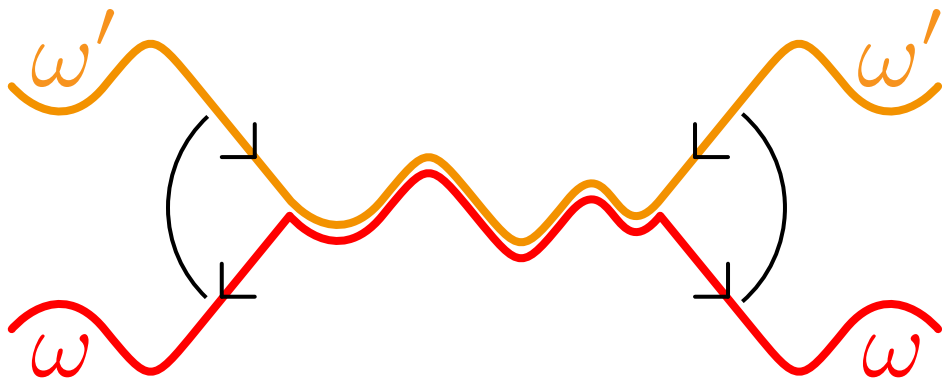

NON-KISSING COMPLEX

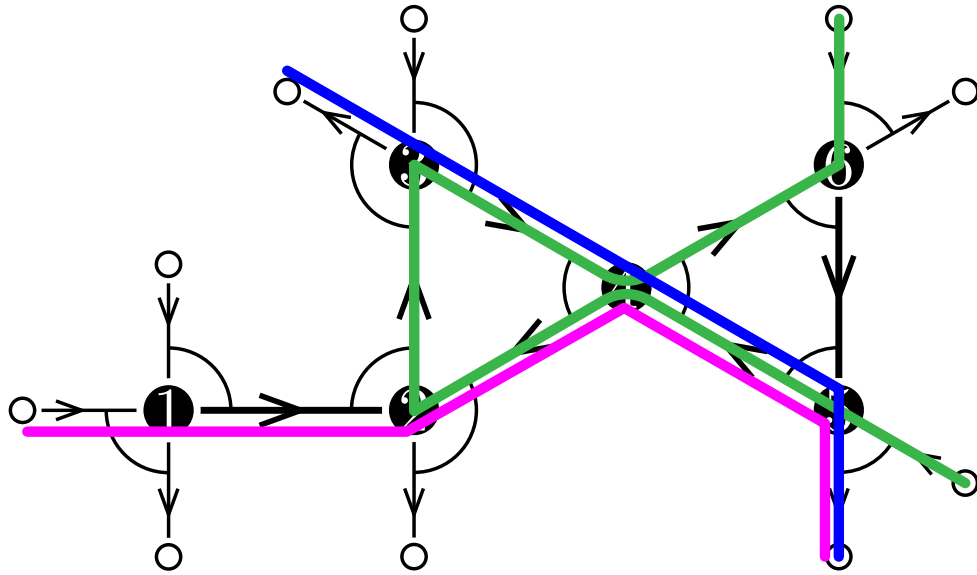

walk $\omega =$ maximal string in Q^*
from blossoms to blossoms

ω kisses ω' if $\Sigma_{\text{top}}(\omega) \cap \Sigma_{\text{bot}}(\omega') \neq \emptyset$

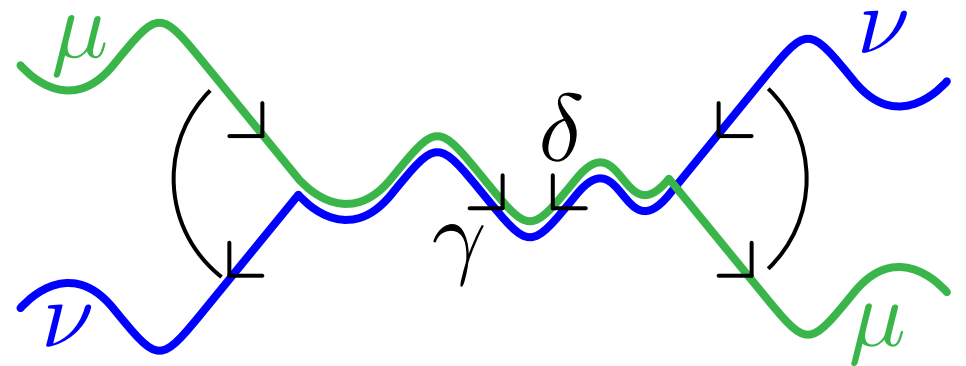
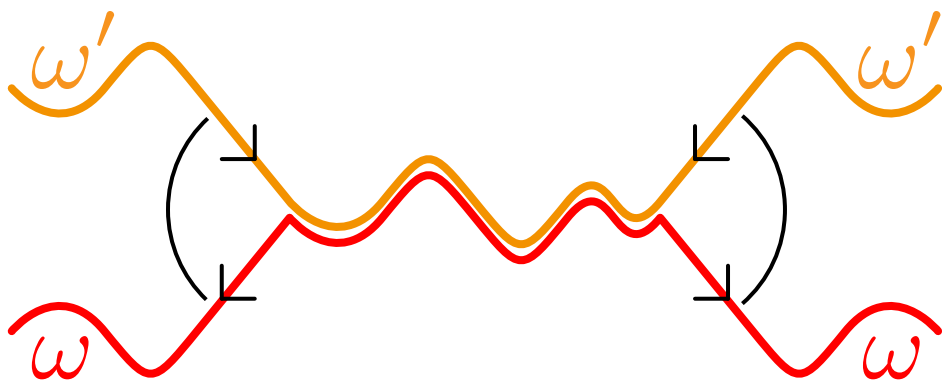

NON-KISSING COMPLEX

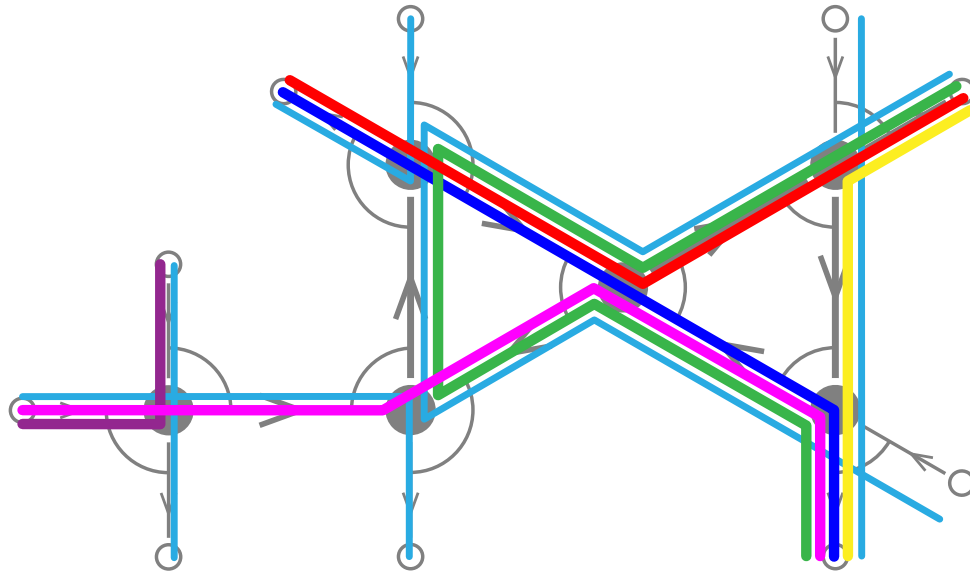

walk $\omega =$ maximal string in Q^*
from blossoms to blossoms

ω kisses ω' if $\Sigma_{\text{top}}(\omega) \cap \Sigma_{\text{bot}}(\omega') \neq \emptyset$

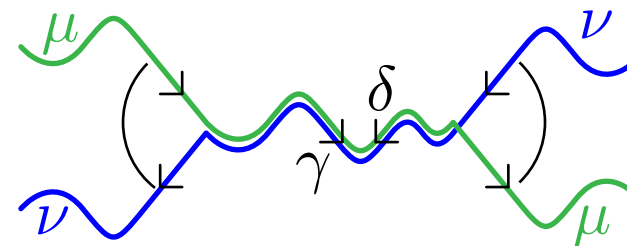
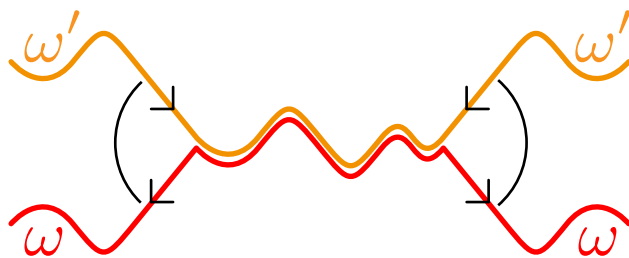

[reduced] non-kissing complex $\mathcal{K}_{\text{nk}}(\bar{Q}) =$ simplicial complex with

- vertices = [bended] walks of \bar{Q} (that are not self-kissing)
- faces = collections of pairwise non-kissing [bended] walks of \bar{Q}

REDUCED NON-KISSING COMPLEX

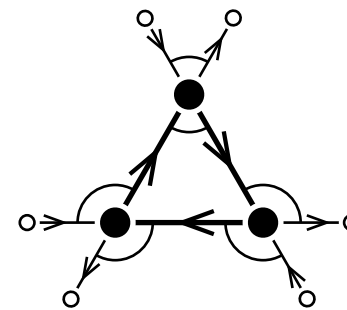
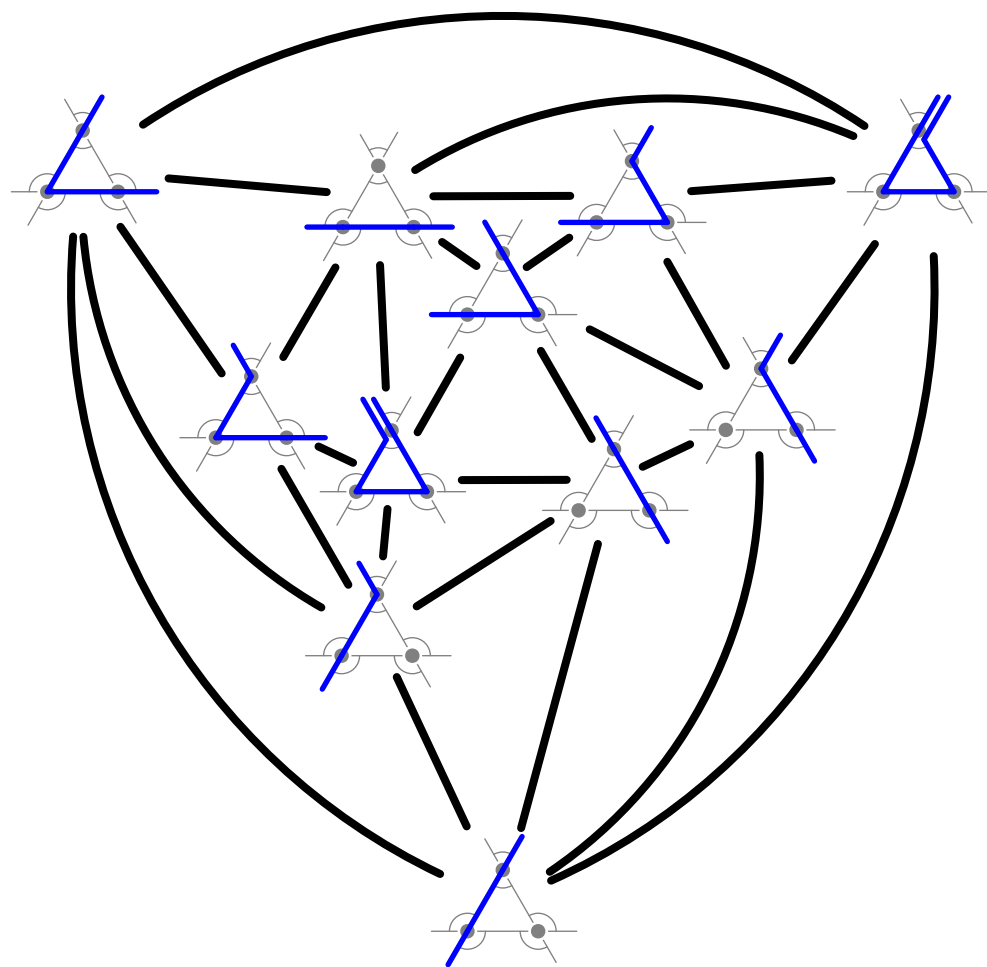
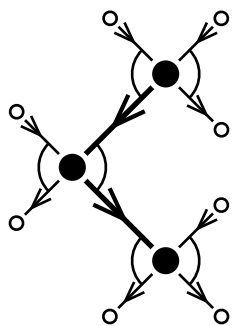
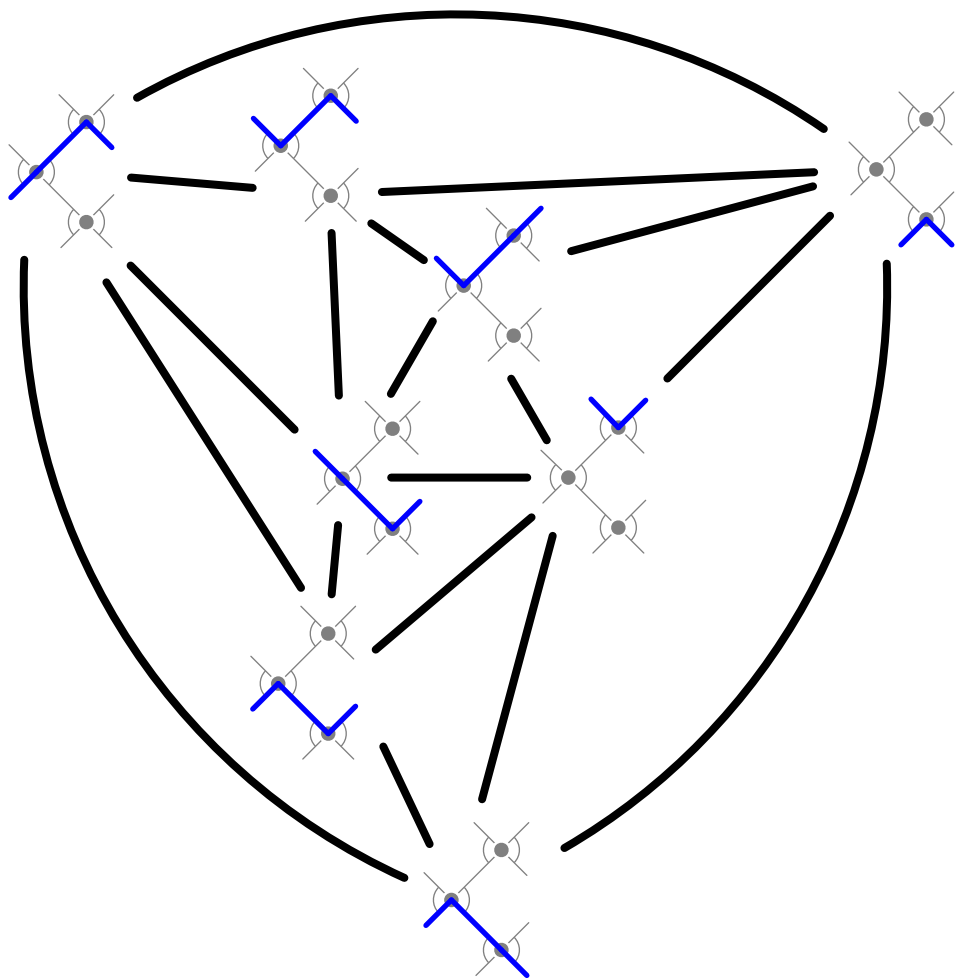

SIMPLICIAL ASSOCIAHEDRA ARE NON-KISSING COMPLEXES

[reduced] simplicial associahedron = simplicial complex with

- vertices = [internal] diagonals of an $(n + 3)$ -gon
- faces = collections of pairwise non-crossing [internal] diagonals of the $(n + 3)$ -gon

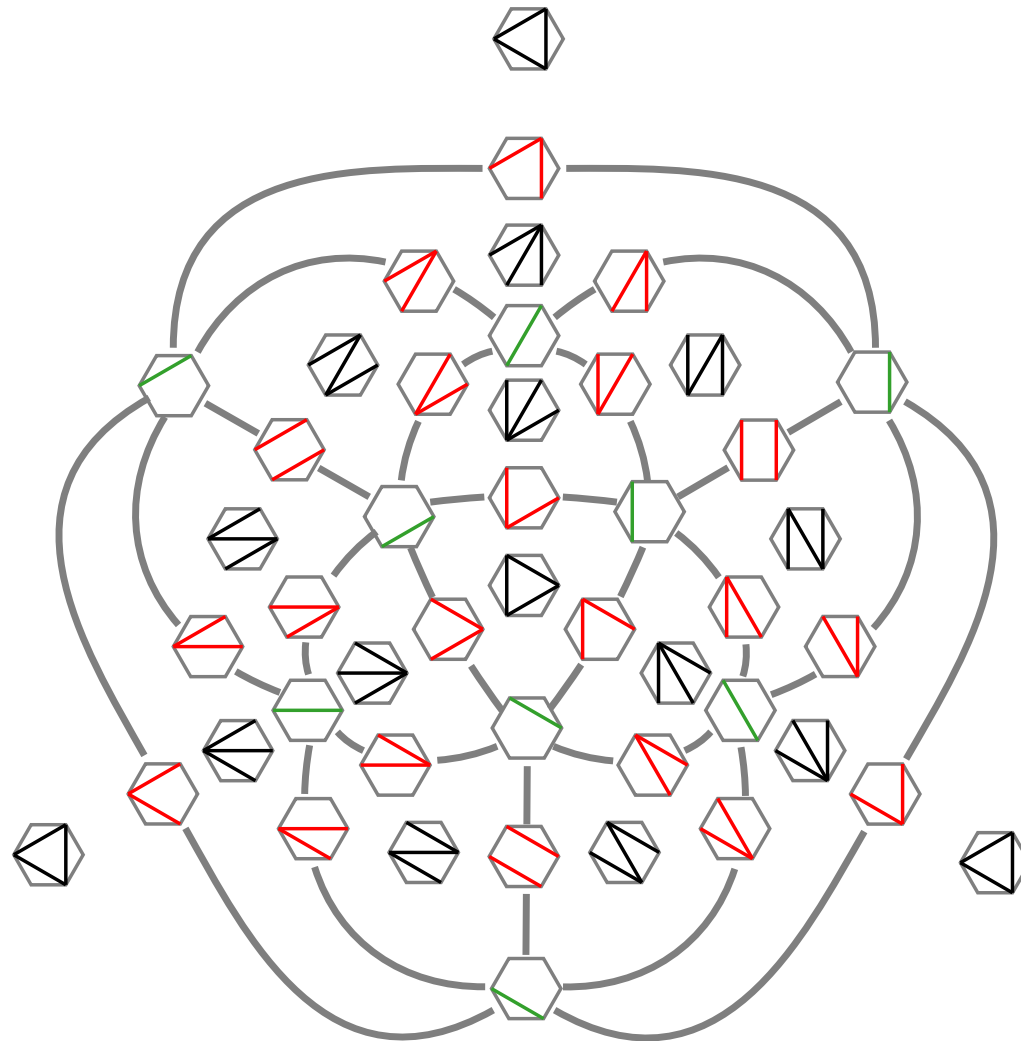

SIMPLICIAL ASSOCIAHEDRA ARE NON-KISSING COMPLEXES

[reduced] simplicial associahedron = simplicial complex with

- vertices = [internal] diagonals of an $(n + 3)$ -gon
- faces = collections of pairwise non-crossing [internal] diagonals of the $(n + 3)$ -gon

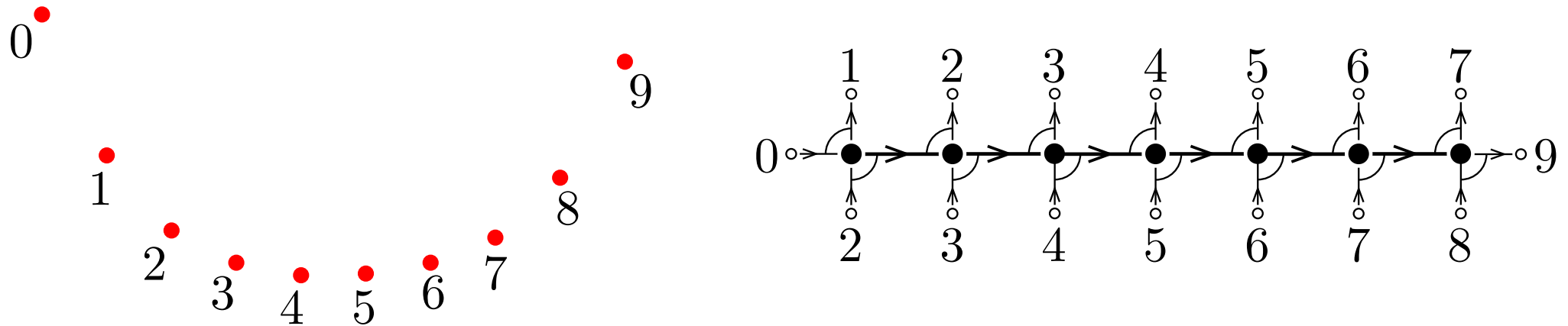

SIMPLICIAL ASSOCIAHEDRA ARE NON-KISSING COMPLEXES

[reduced] simplicial associahedron = simplicial complex with

- vertices = [internal] diagonals of an $(n + 3)$ -gon
- faces = collections of pairwise non-crossing [internal] diagonals of the $(n + 3)$ -gon

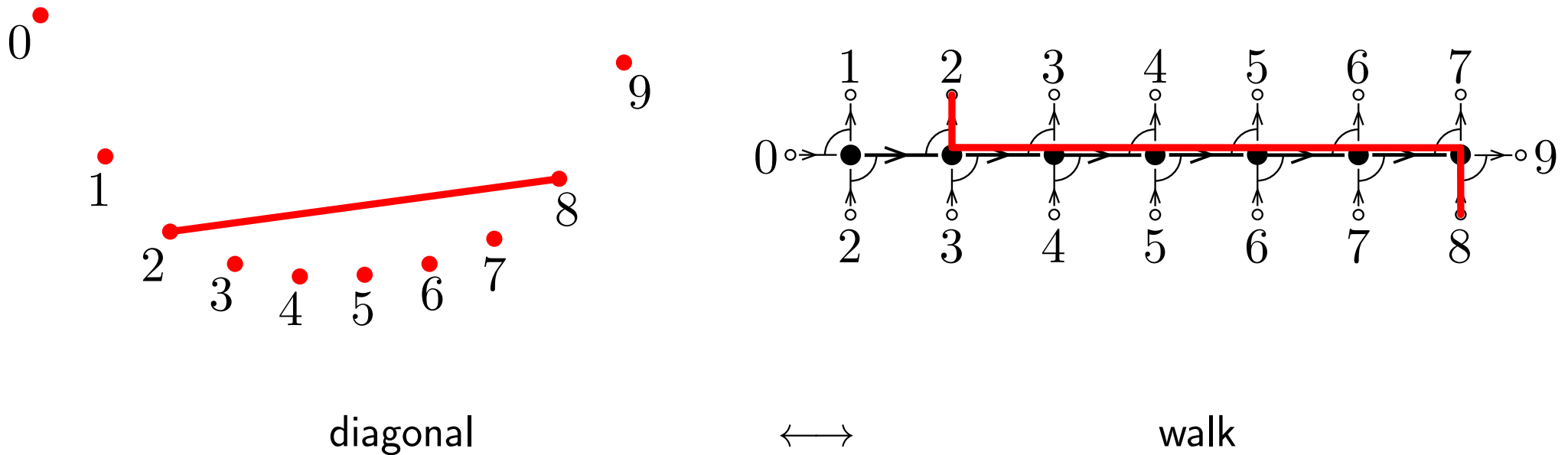

SIMPLICIAL ASSOCIAHEDRA ARE NON-KISSING COMPLEXES

[reduced] simplicial associahedron = simplicial complex with

- vertices = [internal] diagonals of an $(n + 3)$ -gon
- faces = collections of pairwise non-crossing [internal] diagonals of the $(n + 3)$ -gon

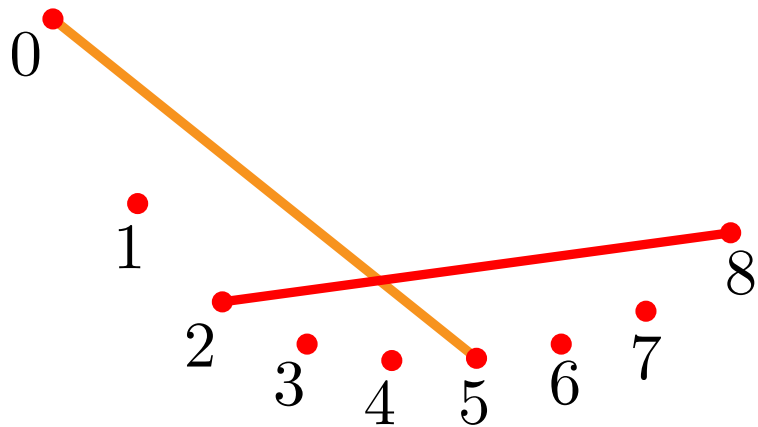

diagonal
crossing

9

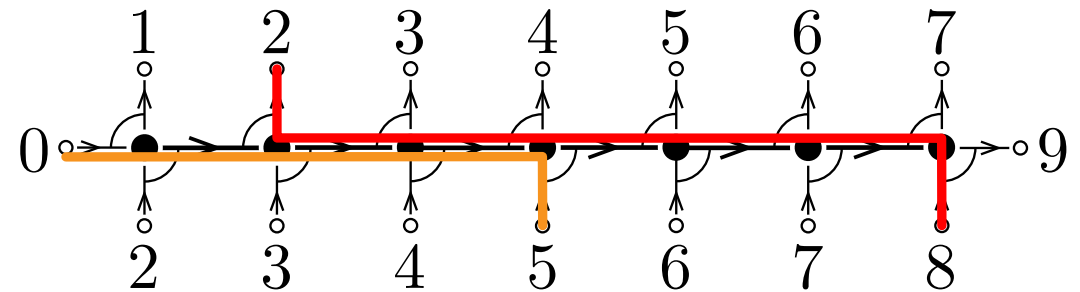

↔

walk

↔

kissing

SIMPLICIAL ASSOCIAHEDRA ARE NON-KISSING COMPLEXES

[reduced] simplicial associahedron = simplicial complex with

- vertices = [internal] diagonals of an $(n + 3)$ -gon
- faces = collections of pairwise non-crossing [internal] diagonals of the $(n + 3)$ -gon

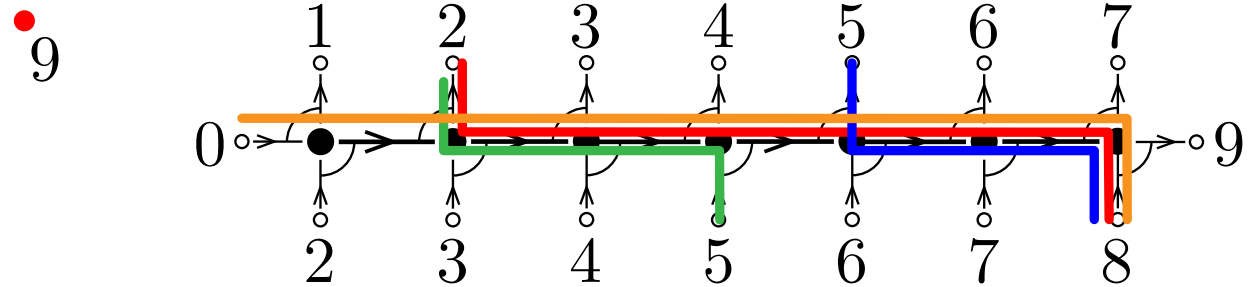
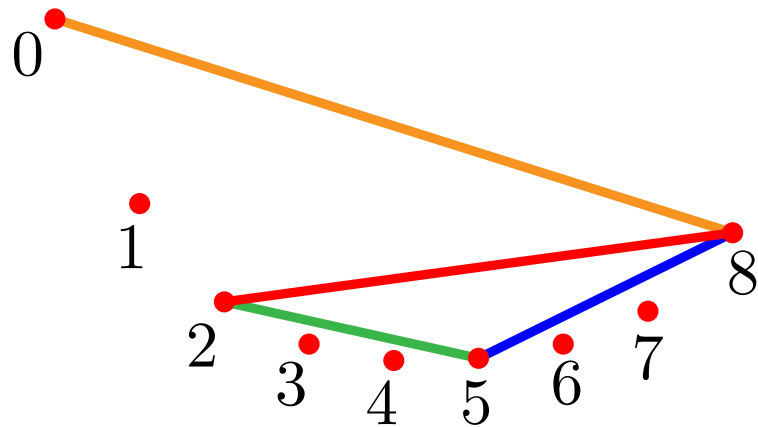

diagonal
crossing
dissection

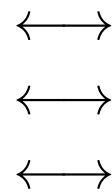

walk
kissing
non-kissing face

SIMPLICIAL ASSOCIAHEDRA ARE NON-KISSING COMPLEXES

[reduced] simplicial associahedron = simplicial complex with

- vertices = [internal] diagonals of an $(n + 3)$ -gon
- faces = collections of pairwise non-crossing [internal] diagonals of the $(n + 3)$ -gon

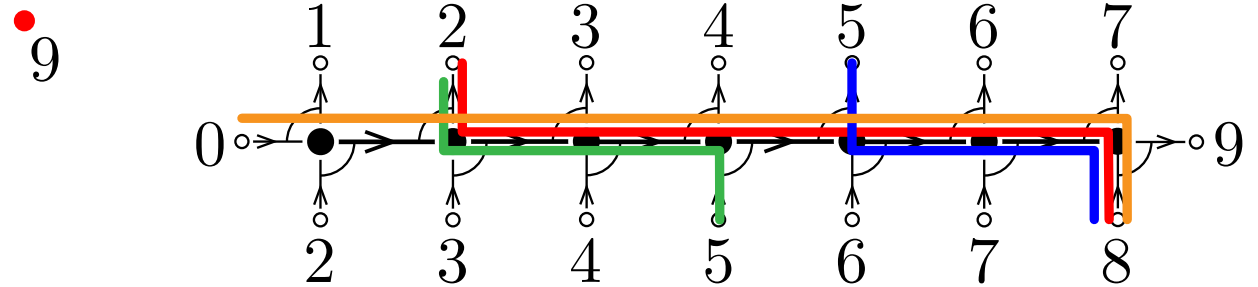
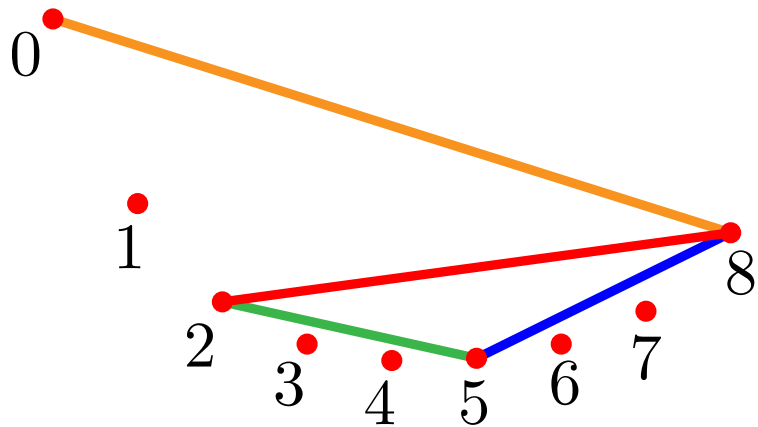

diagonal	\longleftrightarrow	walk
crossing	\longleftrightarrow	kissing
dissection	\longleftrightarrow	non-kissing face
simplicial associahedron	\longleftrightarrow	non-kissing complex

SIMPLICIAL ASSOCIAHEDRA ARE NON-KISSING COMPLEXES

[reduced] simplicial associahedron = simplicial complex with

- vertices = [internal] diagonals of an $(n + 3)$ -gon
- faces = collections of pairwise non-crossing [internal] diagonals of the $(n + 3)$ -gon

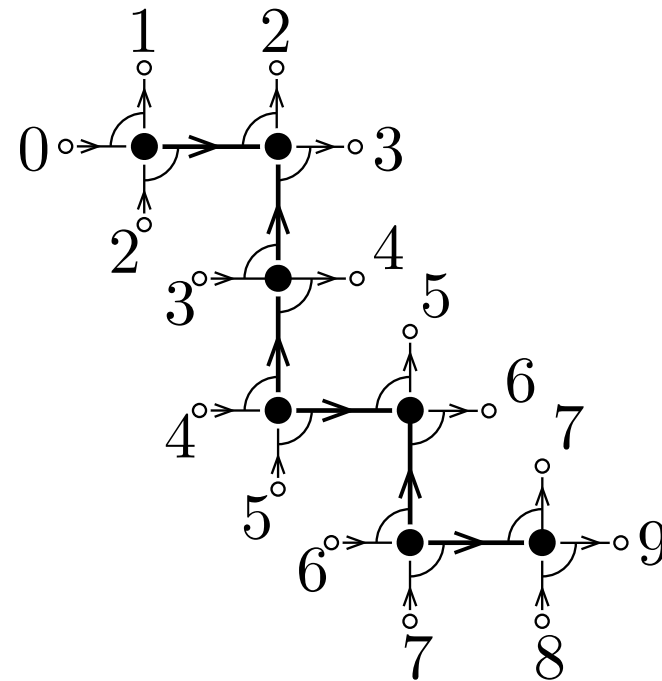
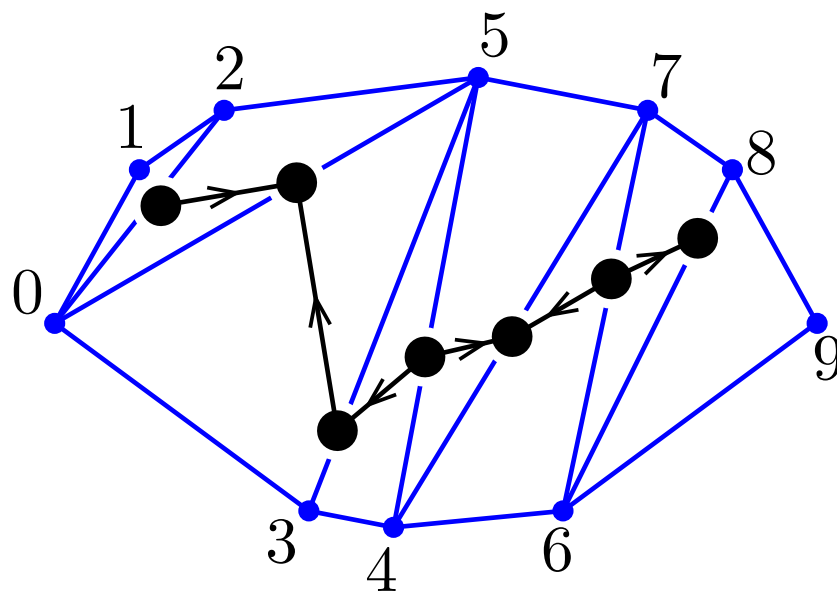

TWO FAMILIES OF NON-KISSING COMPLEXES

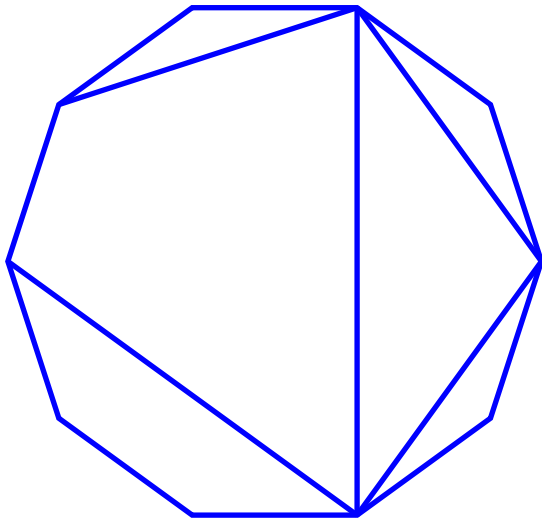

dissection

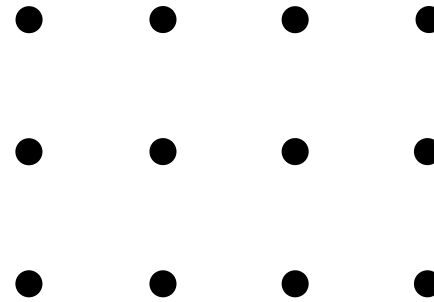

subset of \mathbb{Z}^2

TWO FAMILIES OF NON-KISSING COMPLEXES

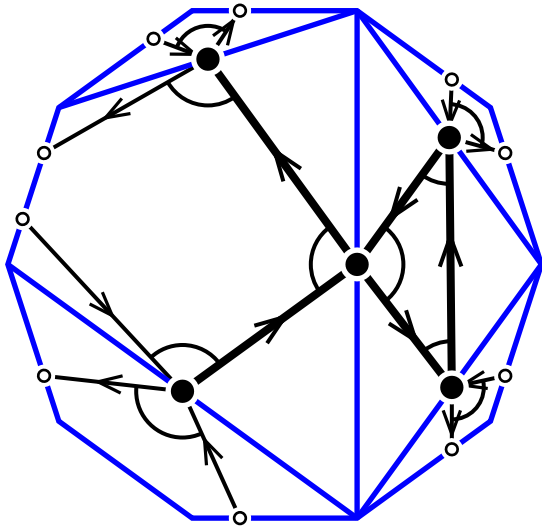

dissection

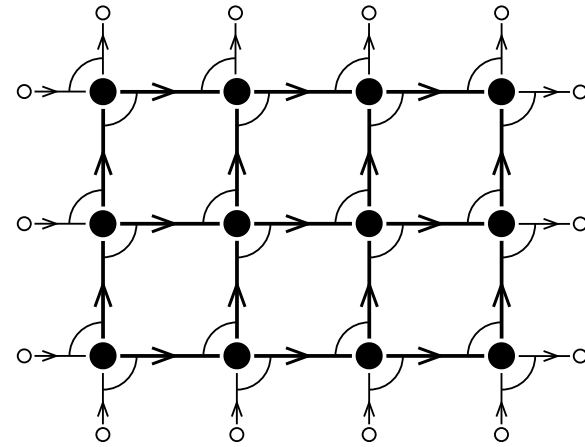

subset of \mathbb{Z}^2

TWO FAMILIES OF NON-KISSING COMPLEXES

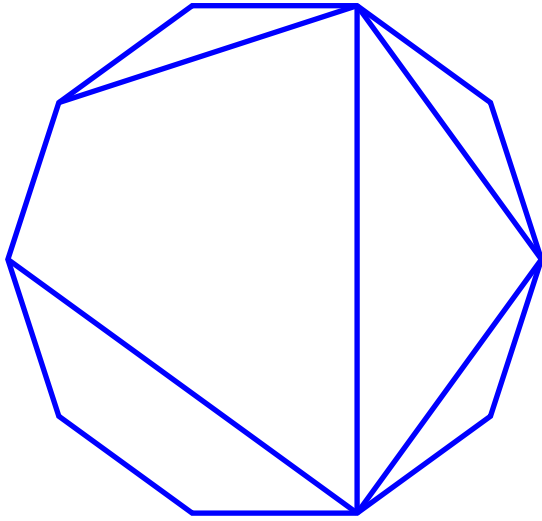

dissection

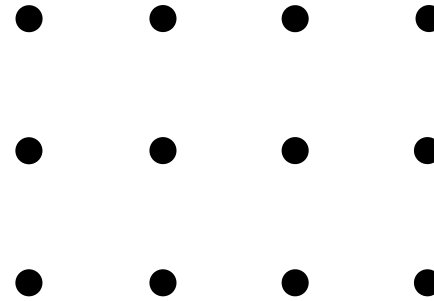

subset of \mathbb{Z}^2

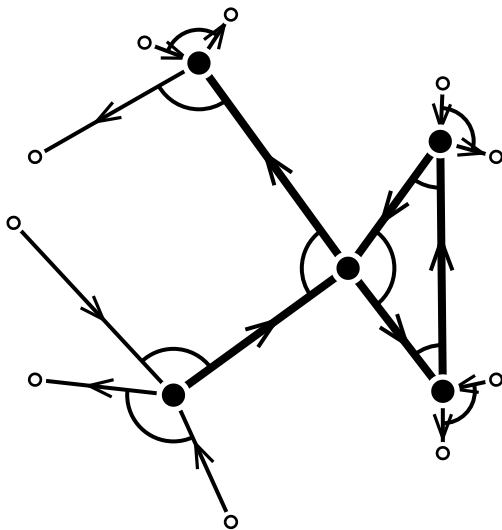

dissection quiver

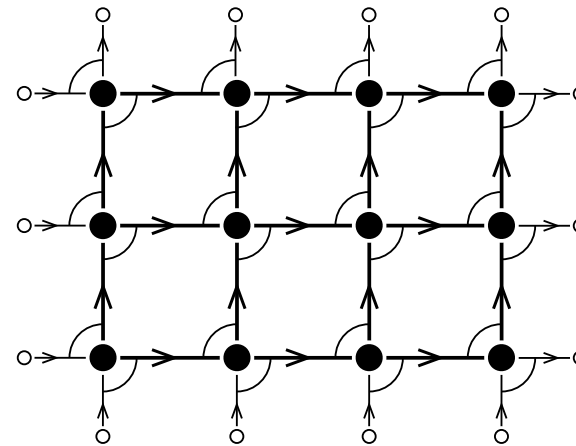

grid quiver

TWO FAMILIES OF NON-KISSING COMPLEXES

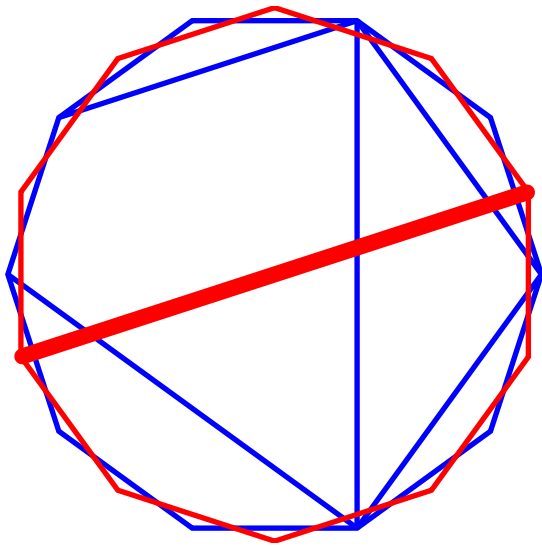

accordion

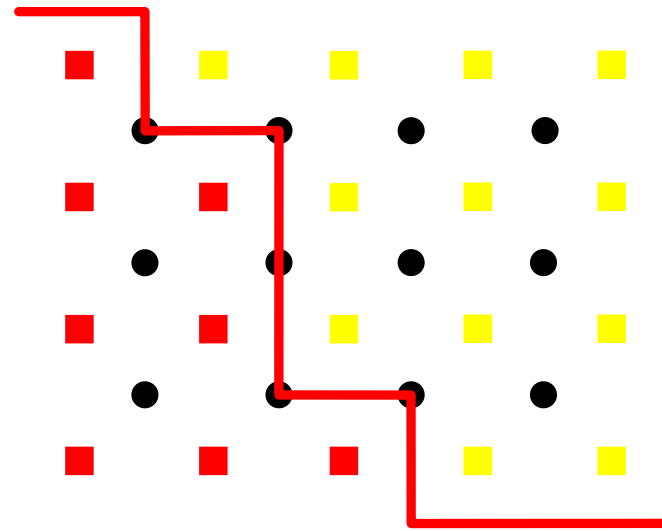

2457 subset of $[n + m]$

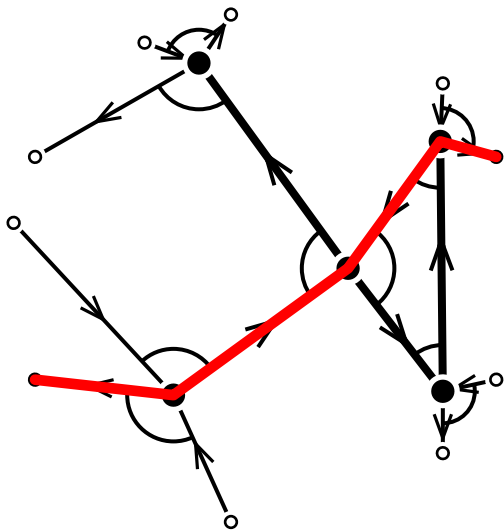

walk

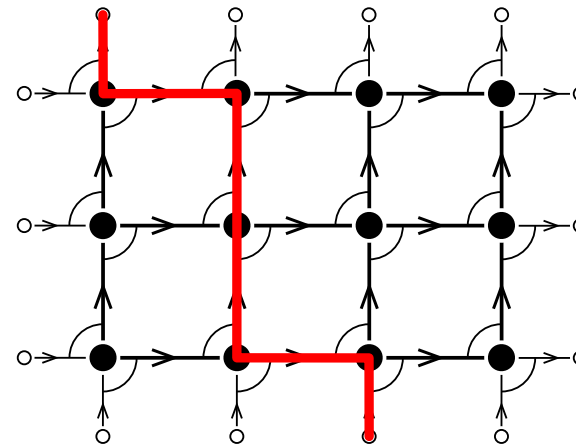

walk

TWO FAMILIES OF NON-KISSING COMPLEXES

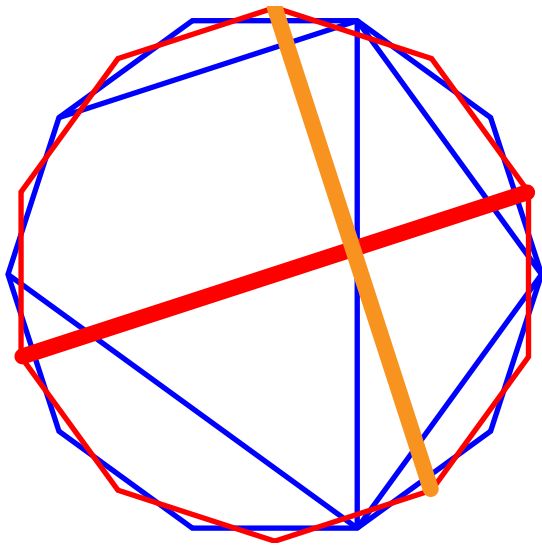

crossing accordions

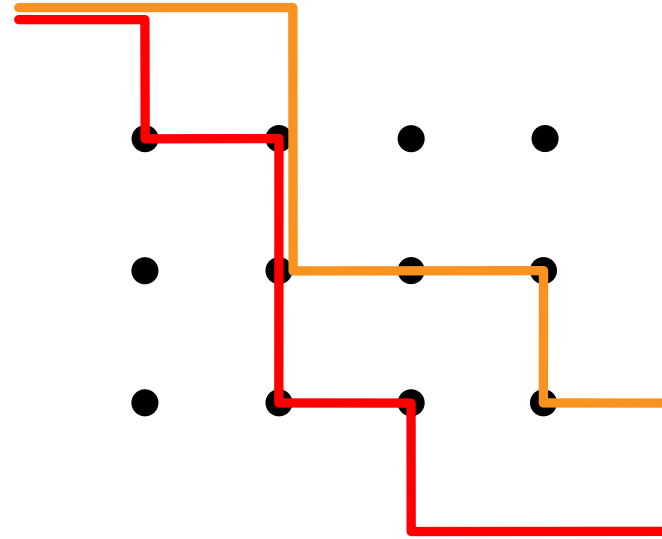

crossing subsets of $[n + m]$

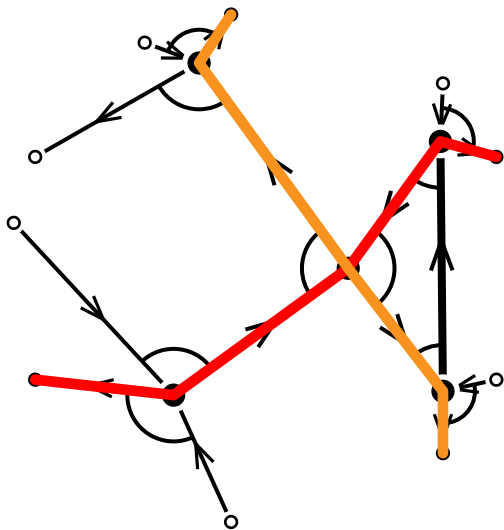

kissing walks

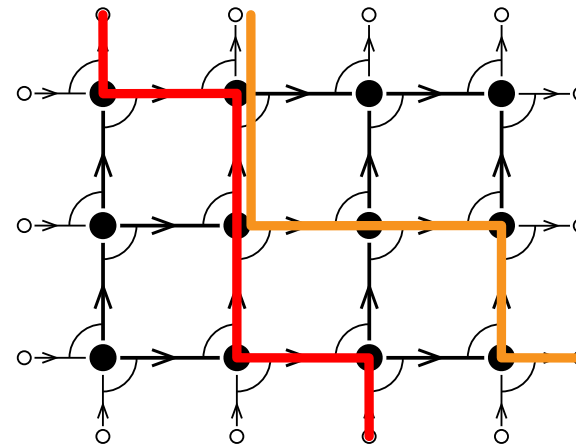

kissing walks

TWO FAMILIES OF NON-KISSING COMPLEXES

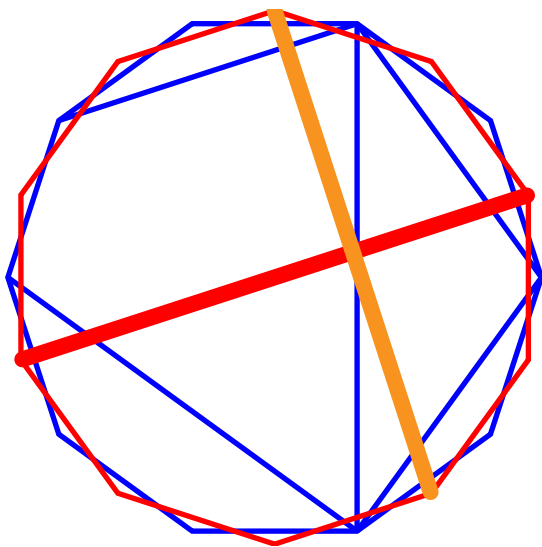

accordion complex

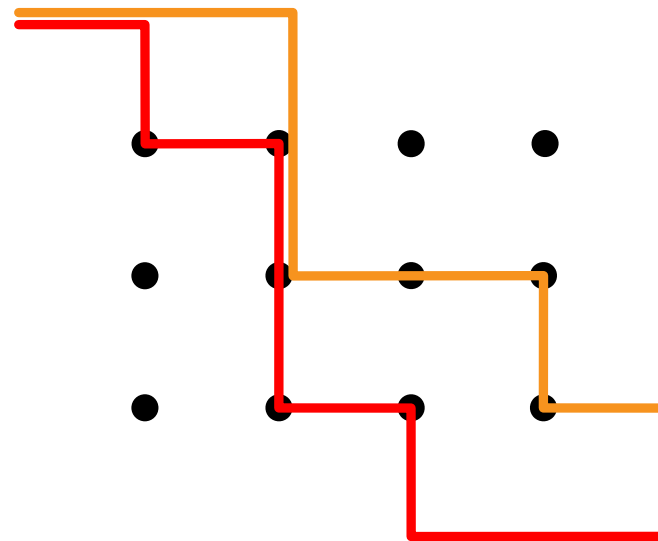

grid Tamari complex

Baryshnikov, On Stokes sets, 2001

Chapoton, Stokes posets and serpent nests, 2016

Garver – McConville, Oriented flip graphs and non-crossing tree partitions, 2017

Petersen – Pylyavskyy – Speyer, A non-crossing standard monomial theory, 2010

Santos – Stump – Welker, Non-crossing sets and the Grassmann-associahedron, 2017

McConville, Lattice structures of grid Tamari orders, 2017

Garver – McConville, Enumerative properties of grid-associahedra, 2017

DISTINGUISHED WALKS, ARROWS AND STRINGS

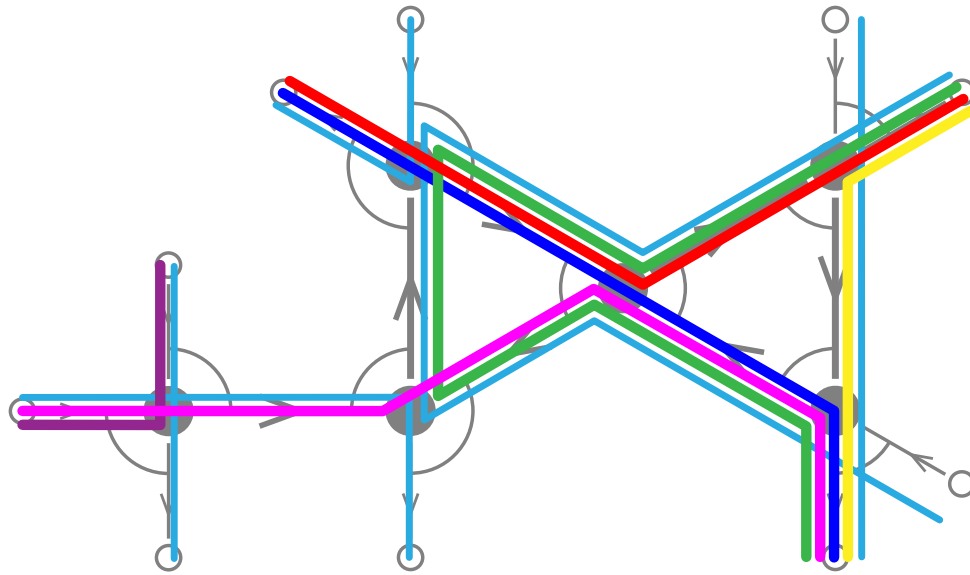

F face of $\mathcal{K}_{\text{nk}}(\bar{Q})$
 $\alpha \in Q_1$

DISTINGUISHED WALKS, ARROWS AND STRINGS

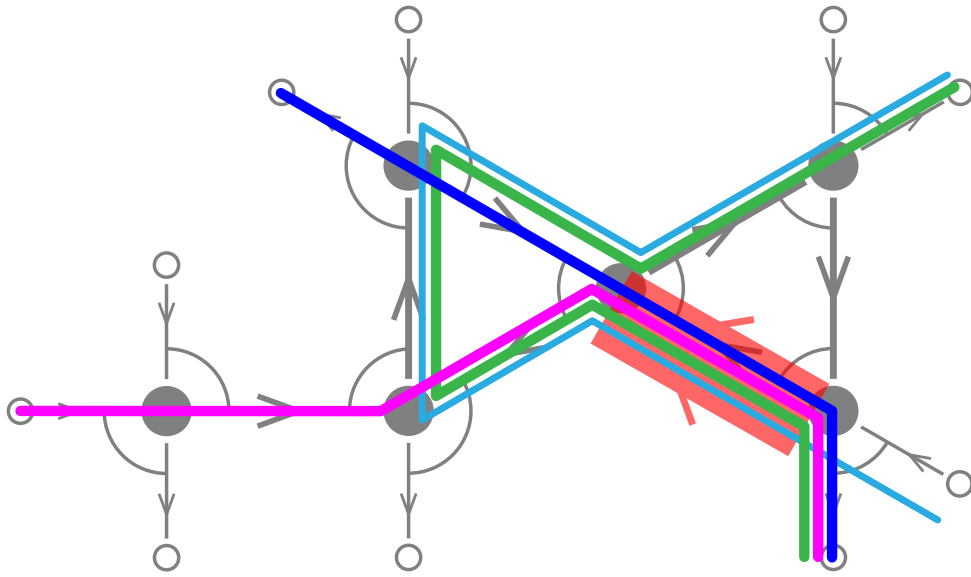

F face of $\mathcal{K}_{\text{nk}}(\bar{Q})$

$\alpha \in Q_1$

$F_\alpha = \{\omega \in F \mid \alpha \in \omega\}$

$\lambda \prec_\alpha \omega$ countercurrent order at α

DISTINGUISHED WALKS, ARROWS AND STRINGS

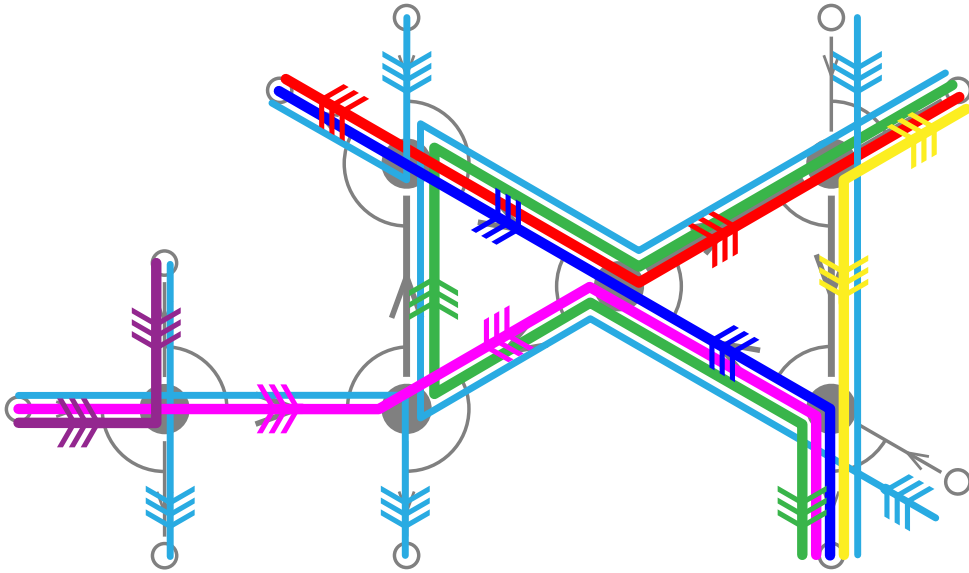

F face of $\mathcal{K}_{\text{nk}}(\bar{Q})$

$\alpha \in Q_1$

$F_\alpha = \{\omega \in F \mid \alpha \in \omega\}$

$\lambda \prec_\alpha \omega$ countercurrent order at α

$\text{dw}(\alpha, F) = \max_{\prec_\alpha} F_\alpha$

$\text{da}(\omega, F) = \{\alpha \in Q_1 \mid \omega = \text{dw}(\alpha, F)\}$

DISTINGUISHED WALKS, ARROWS AND STRINGS

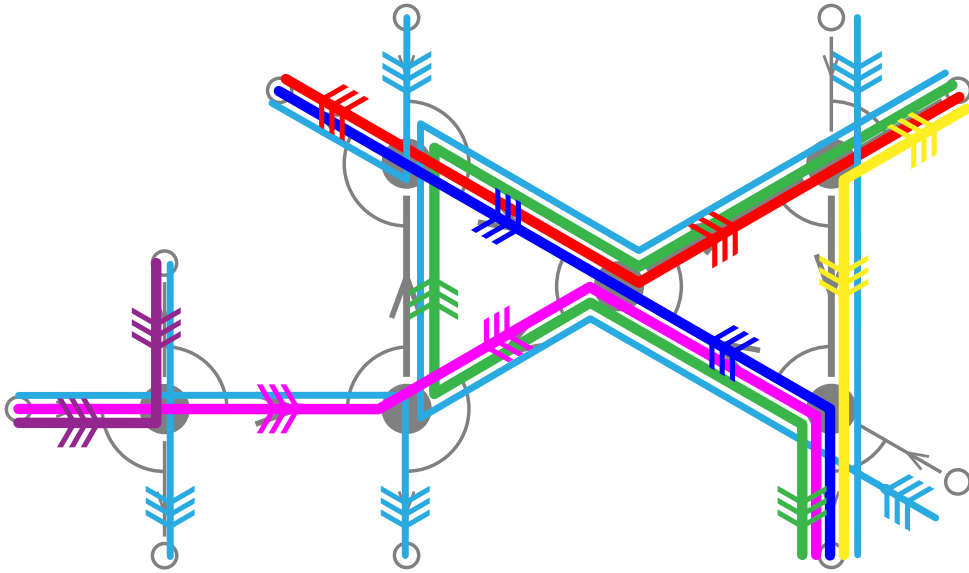

F face of $\mathcal{K}_{\text{nk}}(\bar{Q})$

$\alpha \in Q_1$

$F_\alpha = \{\omega \in F \mid \alpha \in \omega\}$

$\lambda \prec_\alpha \omega$ countercurrent order at α

$\text{dw}(\alpha, F) = \max_{\prec_\alpha} F_\alpha$

$\text{da}(\omega, F) = \{\alpha \in Q_1 \mid \omega = \text{dw}(\alpha, F)\}$

PROP. For any facet $F \in \mathcal{K}_{\text{nk}}(\bar{Q})$,

- each bended walk of F contains 2 distinguished arrows in F pointing opposite,
- each straight walk of F contains 1 distinguished arrows in F pointing as the walk.

DISTINGUISHED WALKS, ARROWS AND STRINGS

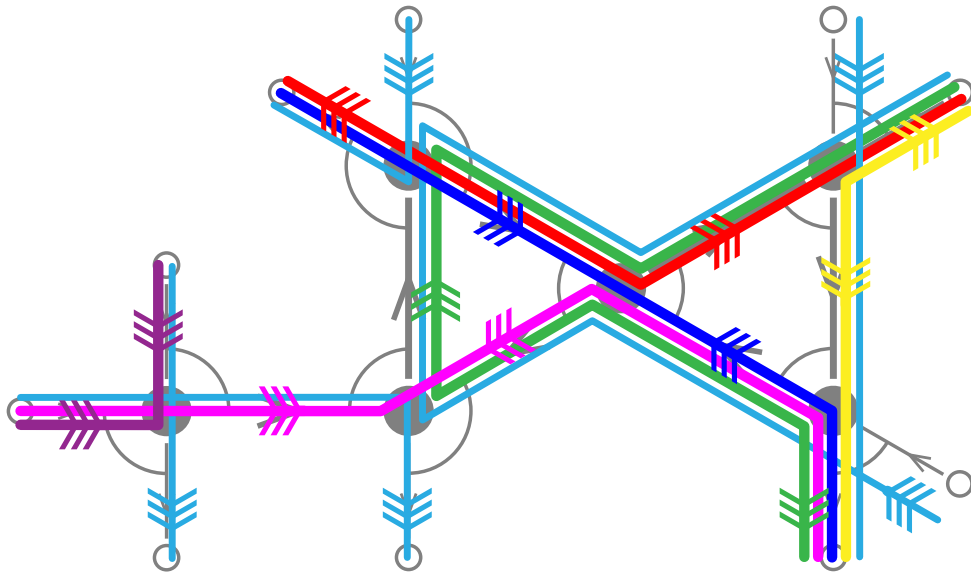

F face of $\mathcal{K}_{\text{nk}}(\bar{Q})$

$\alpha \in Q_1$

$F_\alpha = \{\omega \in F \mid \alpha \in \omega\}$

$\lambda \prec_\alpha \omega$ countercurrent order at α

$\text{dw}(\alpha, F) = \max_{\prec_\alpha} F_\alpha$

$\text{da}(\omega, F) = \{\alpha \in Q_1 \mid \omega = \text{dw}(\alpha, F)\}$

PROP. For any facet $F \in \mathcal{K}_{\text{nk}}(\bar{Q})$,

- each bended walk of F contains 2 distinguished arrows in F pointing opposite,
- each straight walk of F contains 1 distinguished arrows in F pointing as the walk.

CORO. $\mathcal{K}_{\text{nk}}(\bar{Q})$ is pure of dimension $|Q_0|$.

FLIPS

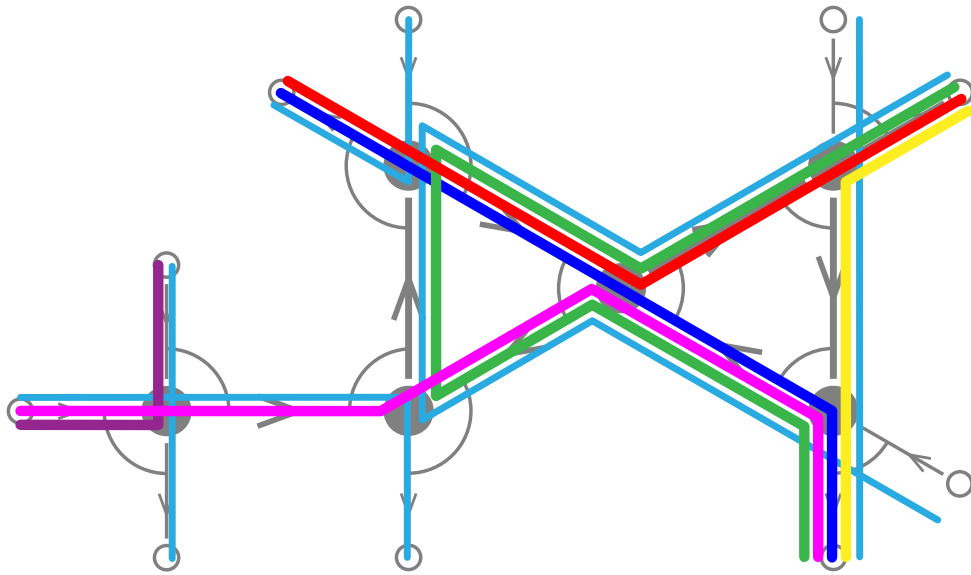

F facet of $\mathcal{K}_{\text{nk}}(\bar{Q})$ (ie. maximal collection of pairwise non-kissing walks)

FLIPS

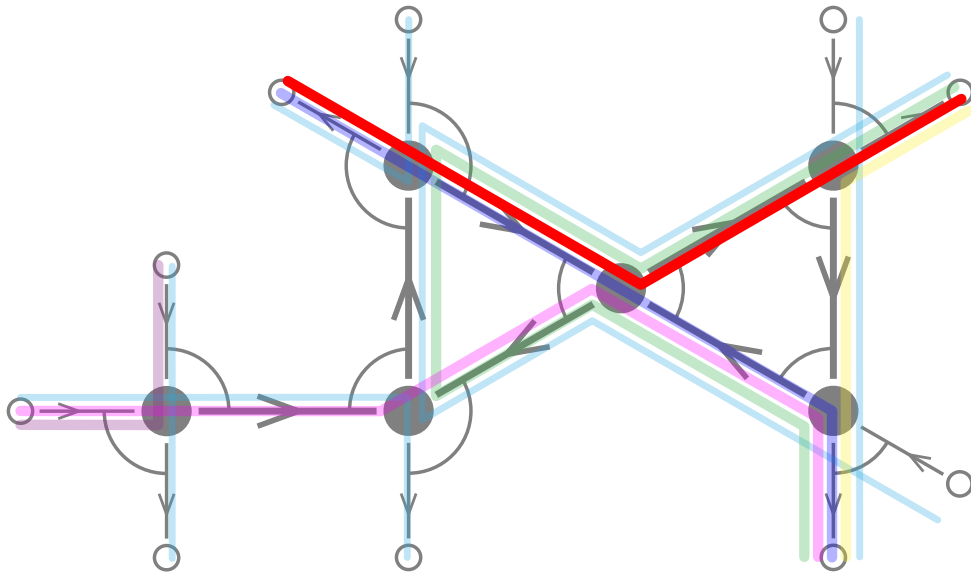

F facet of $\mathcal{K}_{\text{nk}}(\bar{Q})$ (ie. maximal collection of pairwise non-kissing walks)
 $\omega \in F$ we want to “flip”

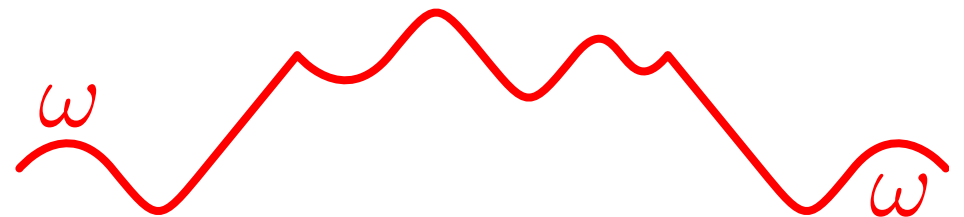

FLIPS

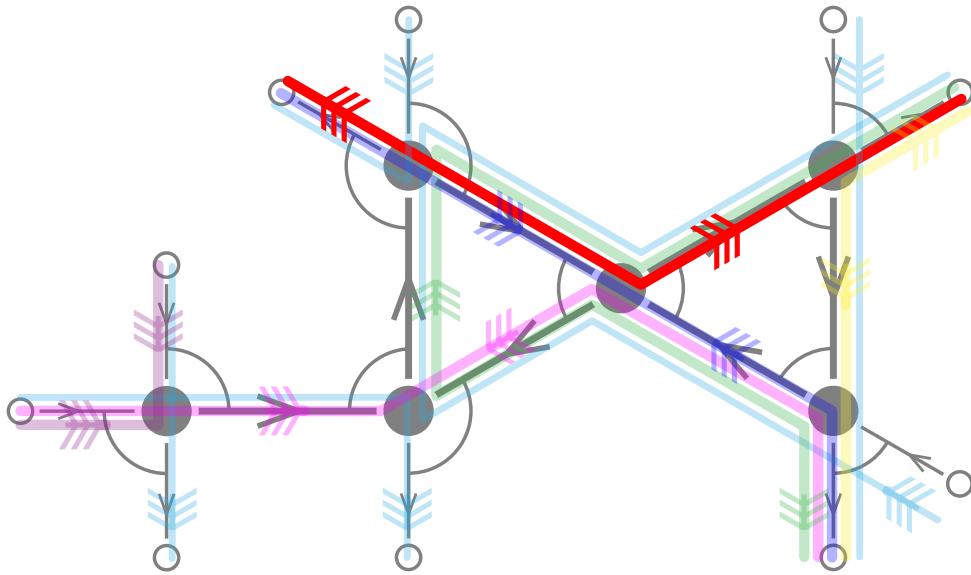

F facet of $\mathcal{K}_{\text{nk}}(\bar{Q})$ (ie. maximal collection of pairwise non-kissing walks)

$\omega \in F$ we want to “flip”

$\{\alpha, \beta\} = \text{da}(\omega, F)$

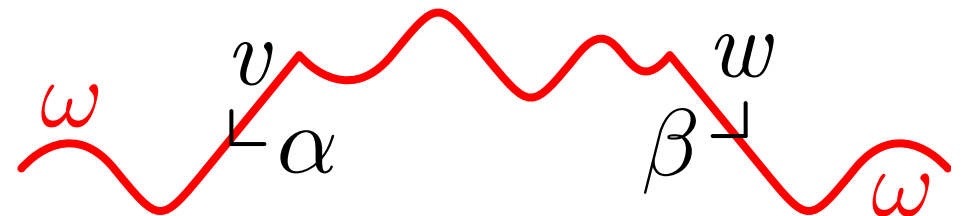

FLIPS

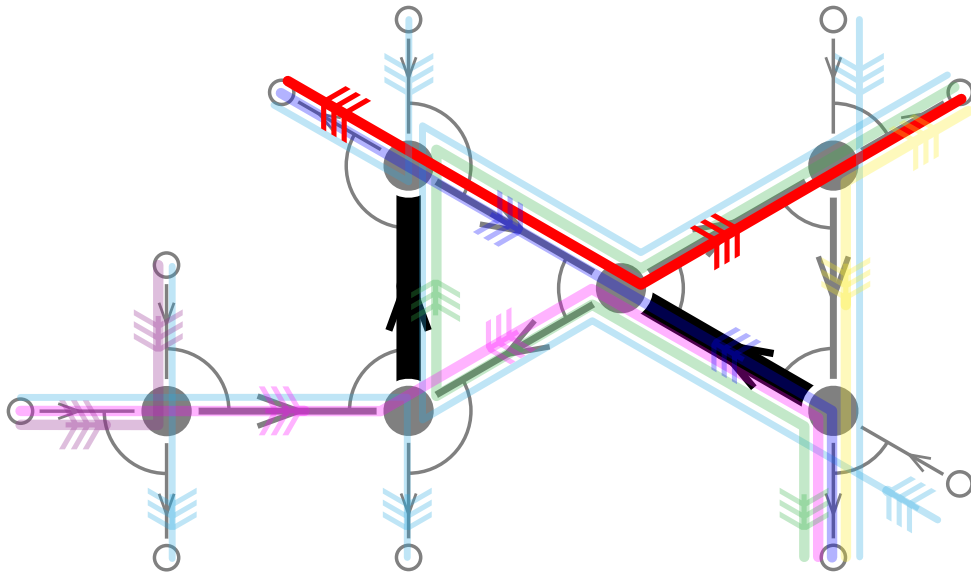

F facet of $\mathcal{K}_{\text{nk}}(\bar{Q})$ (ie. maximal collection of pairwise non-kissing walks)

$\omega \in F$ we want to “flip”

$\{\alpha, \beta\} = \text{da}(\omega, F)$

$\alpha', \beta' \in Q_1$ such that $\alpha'\alpha \in I$ and $\beta'\beta \in I$

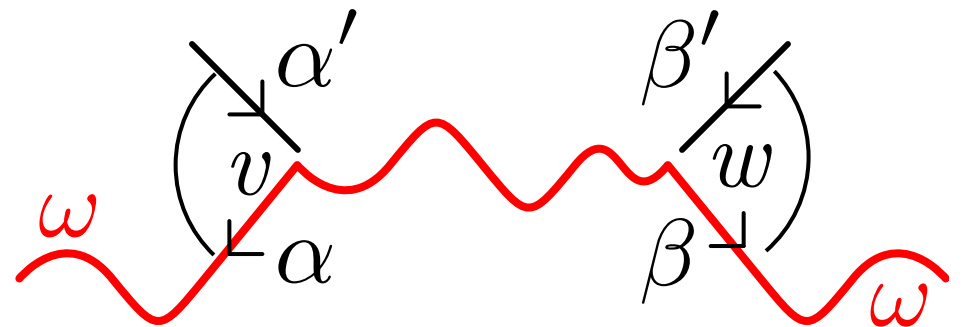

FLIPS

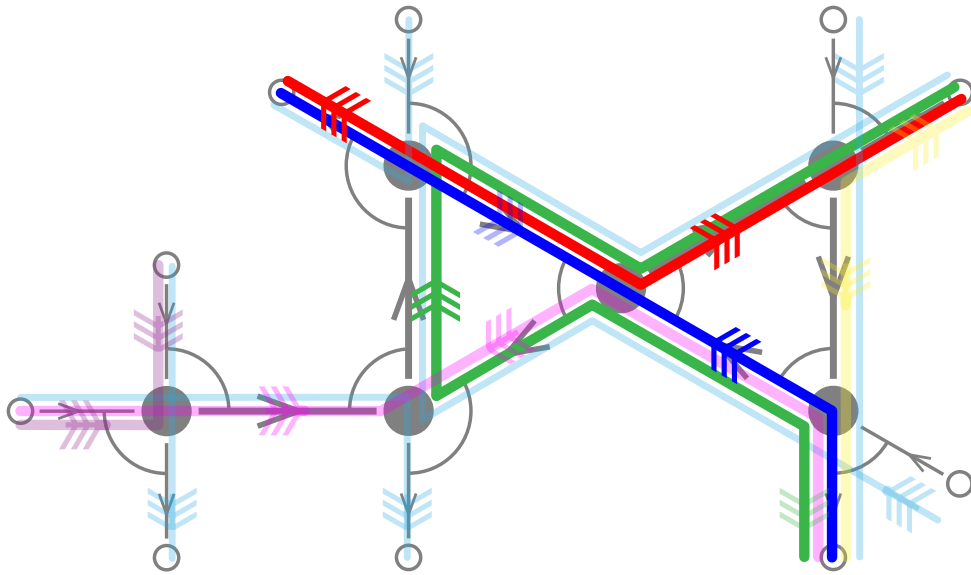

F facet of $\mathcal{K}_{\text{nk}}(\bar{Q})$ (ie. maximal collection of pairwise non-kissing walks)

$\omega \in F$ we want to “flip”

$\{\alpha, \beta\} = \text{da}(\omega, F)$

$\alpha', \beta' \in Q_1$ such that $\alpha'\alpha \in I$ and $\beta'\beta \in I$

$\mu = \text{dw}(\alpha, F)$ and $\nu = \text{dw}(\beta, F)$

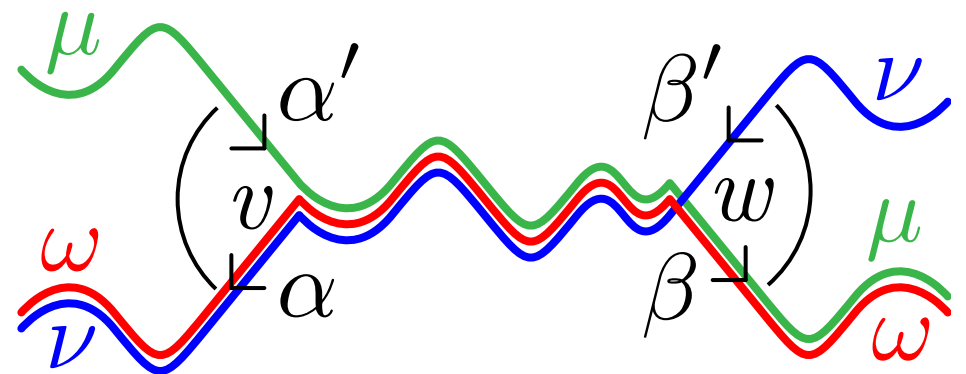

FLIPS

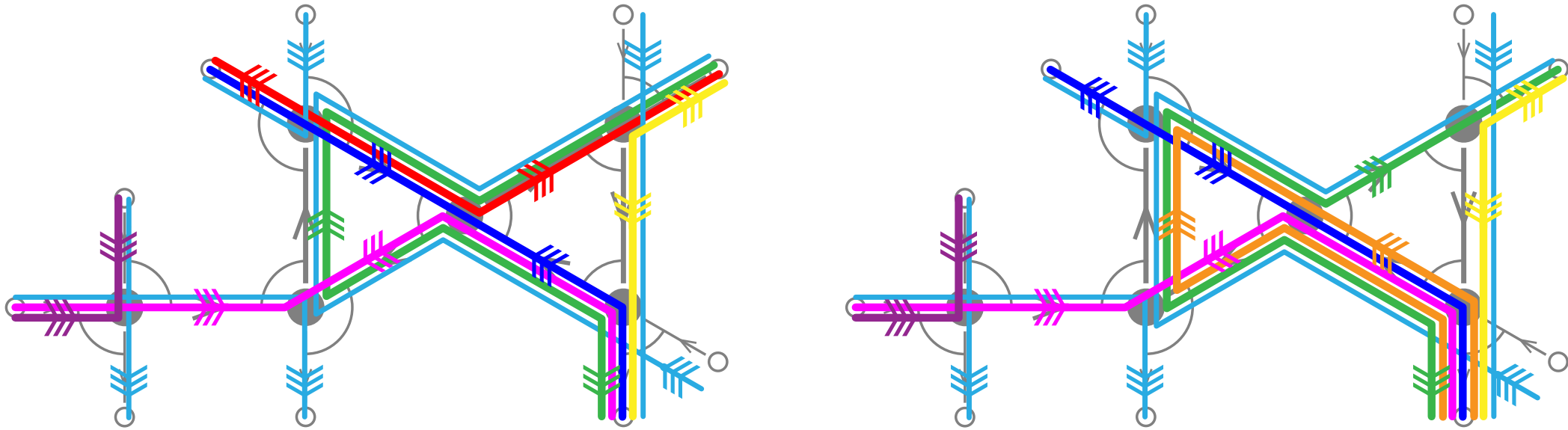

F facet of $\mathcal{K}_{\text{nk}}(\bar{Q})$ (ie. maximal collection of pairwise non-kissing walks)

$\omega \in F$ we want to “flip”

$\{\alpha, \beta\} = \text{da}(\omega, F)$

$\alpha', \beta' \in Q_1$ such that $\alpha'\alpha \in I$ and $\beta'\beta \in I$

$\mu = \text{dw}(\alpha, F)$ and $\nu = \text{dw}(\beta, F)$

$\omega' = \mu[\cdot, v] \sigma \nu[w, \cdot]$

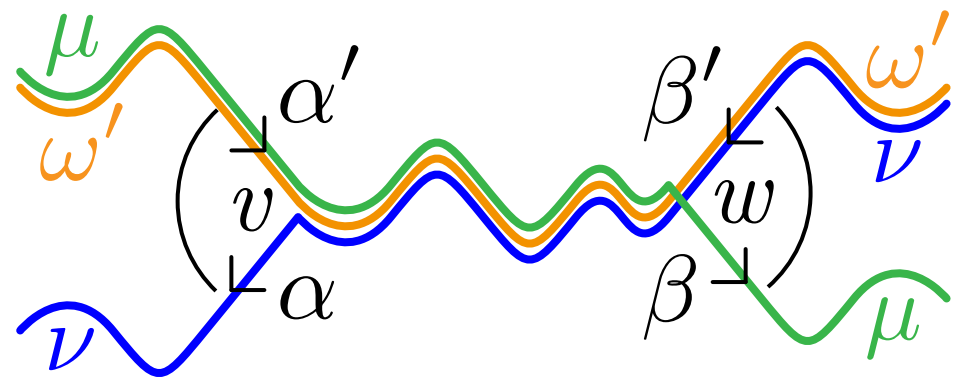

FLIPS

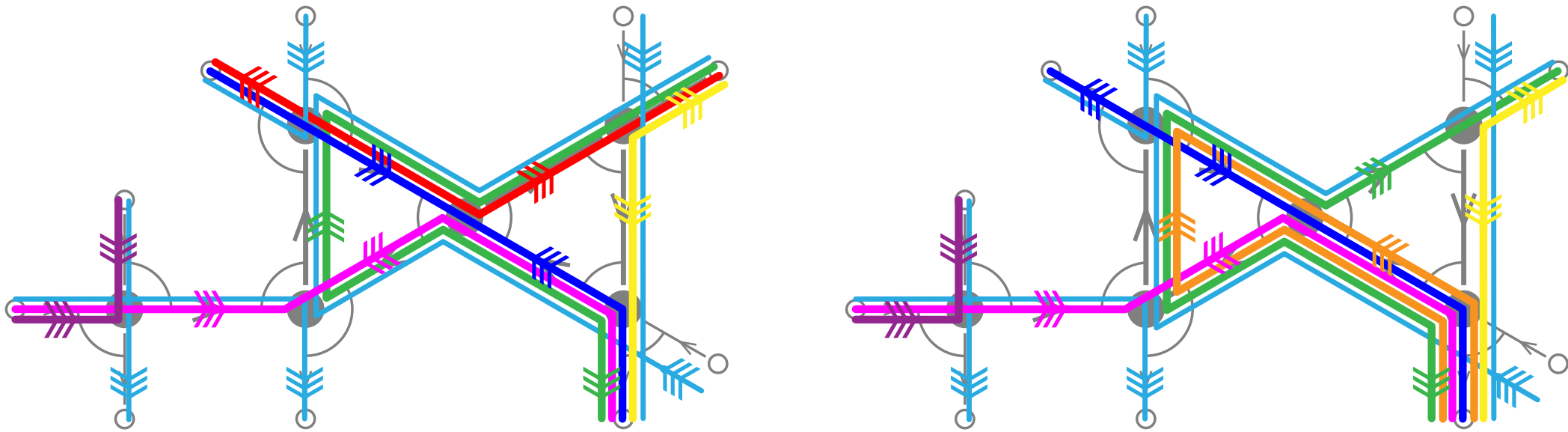

PROP. ω' kisses ω but no other walk of F . Moreover, ω' is the only such walk.

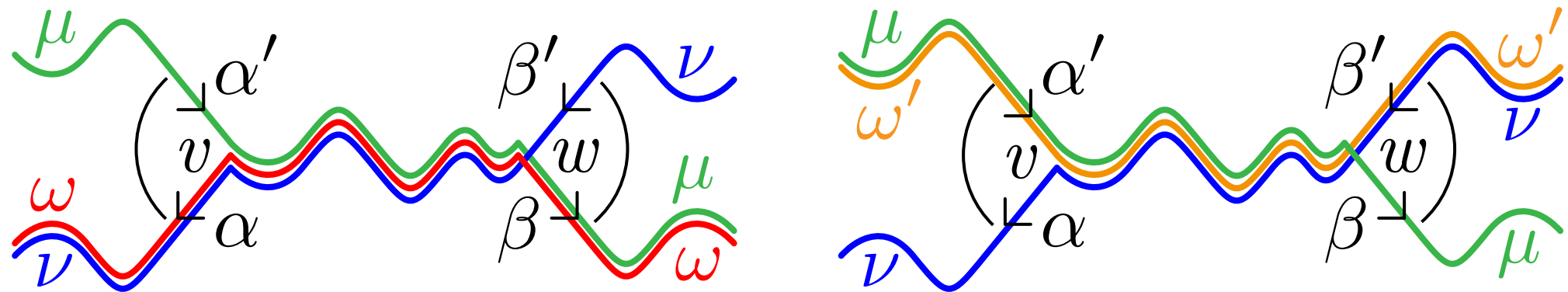

FLIP GRAPH

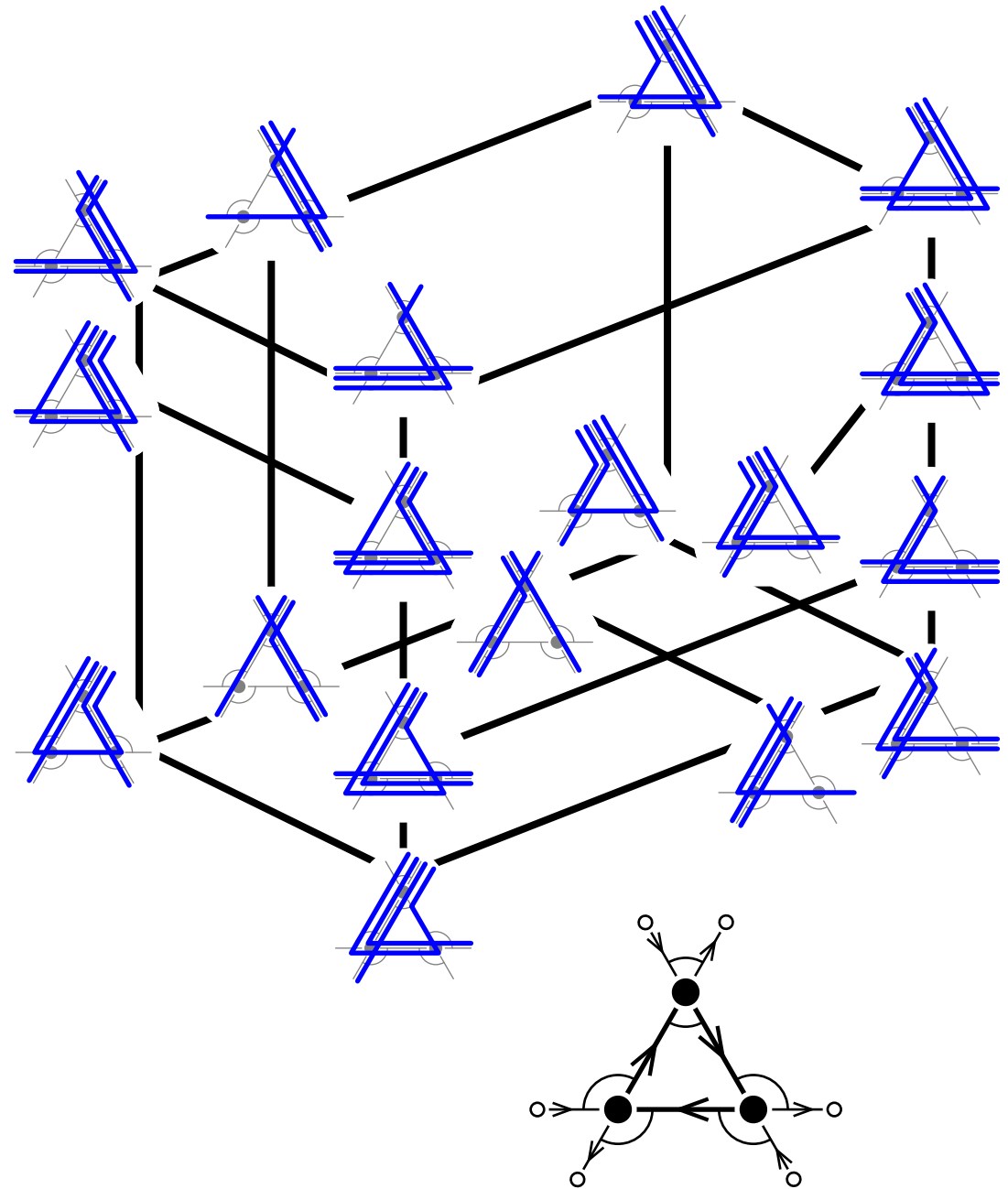
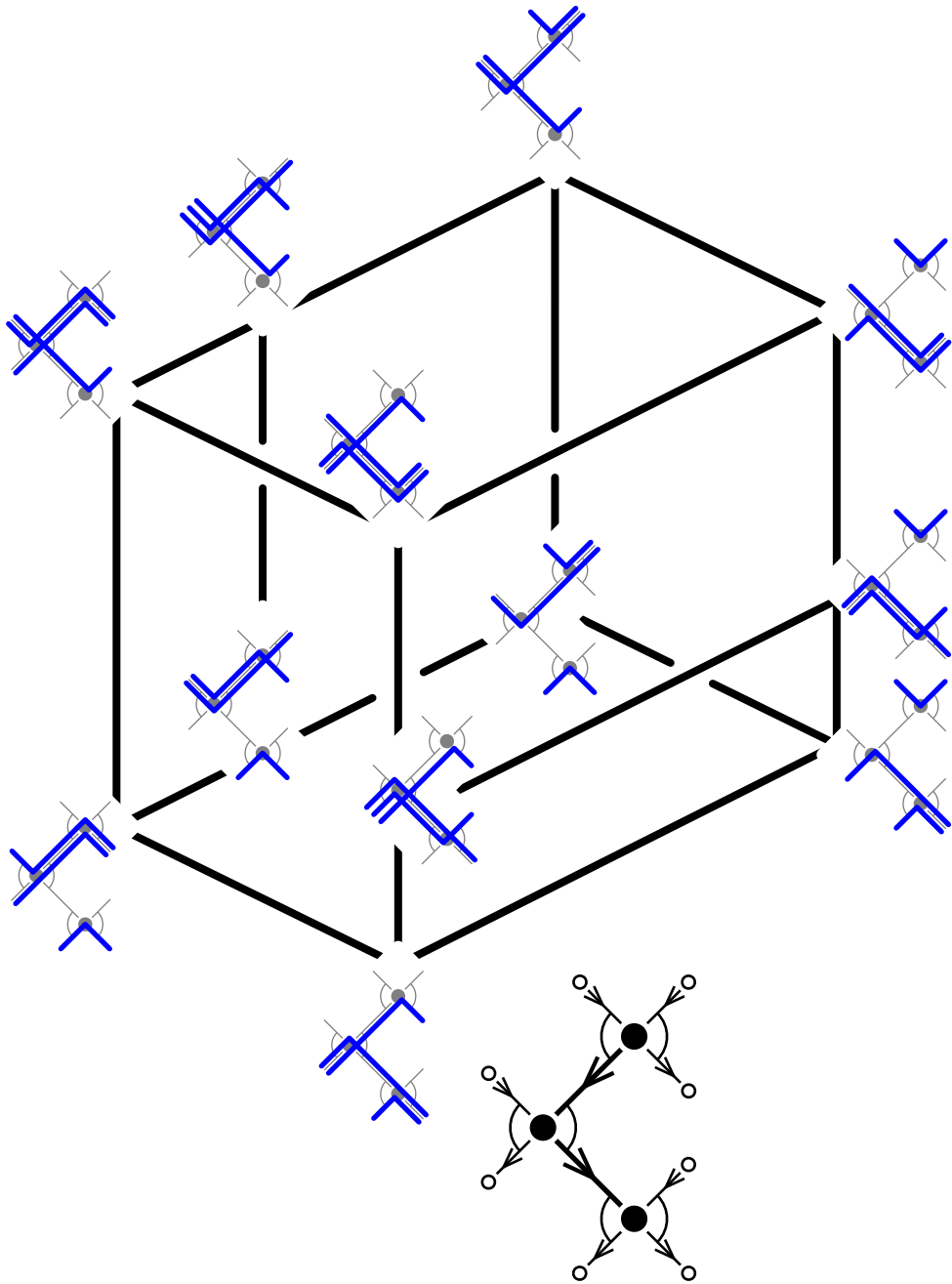

NON-KISSING ASSOCIAHEDRA

SIMPLICIAL COMPLEX

simplicial complex = collection of subsets of X downward closed

exm:

$$X = [n] \cup \overline{[n]}$$

$$\Delta = \{I \subseteq X \mid \forall i \in [n], \{i, \underline{i}\} \not\subseteq I\}$$

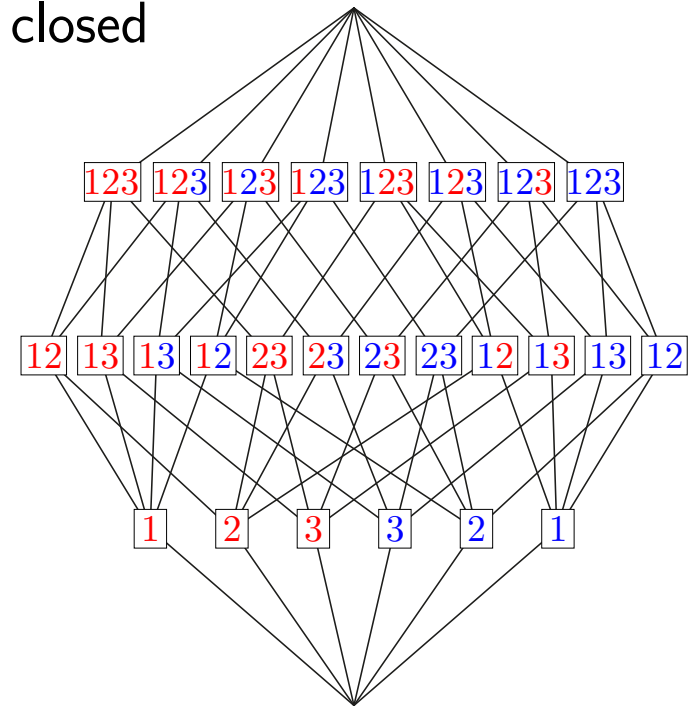

FANS

polyhedral cone = positive span of a finite set of \mathbb{R}^d
= intersection of finitely many linear half-spaces

fan = collection of polyhedral cones closed by faces
and where any two cones intersect along a face

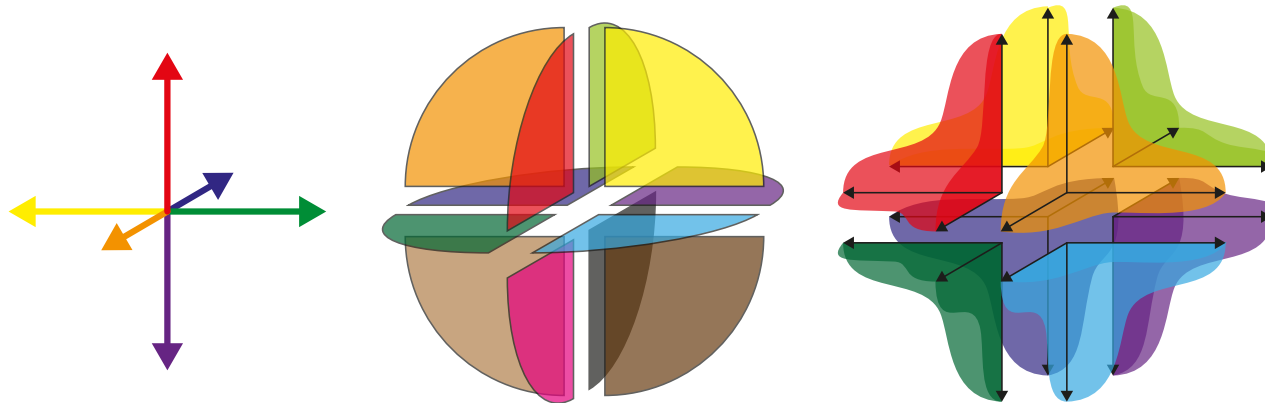
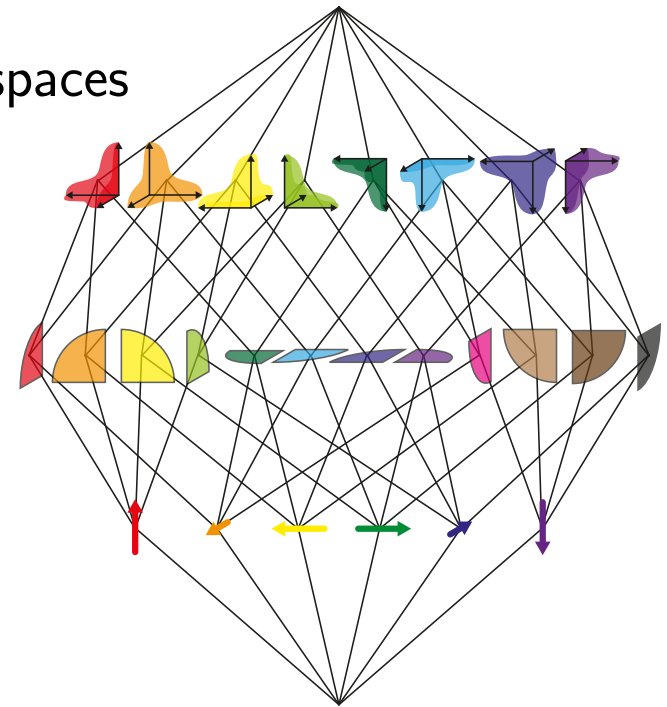

simplicial fan = maximal cones generated by d rays

POLYTOPES

polytope = convex hull of a finite set of \mathbb{R}^d
= bounded intersection of finitely many affine half-spaces

face = intersection with a supporting hyperplane

face lattice = all the faces with their inclusion relations

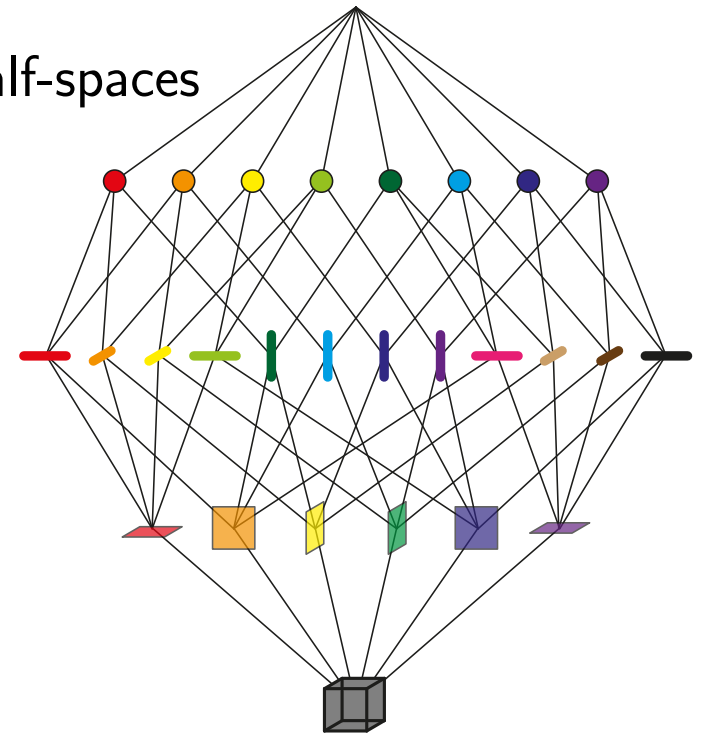
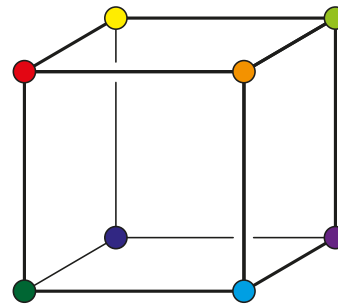
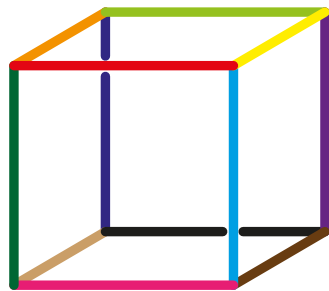
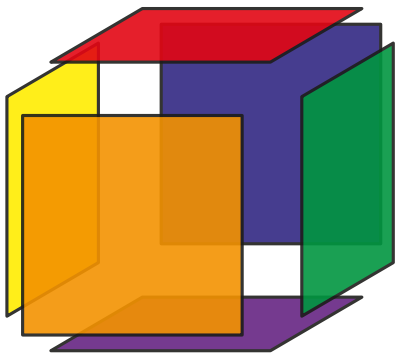

simple polytope = facets in general position = each vertex incident to d facets

SIMPLICIAL COMPLEXES, FANS, AND POLYTOPES

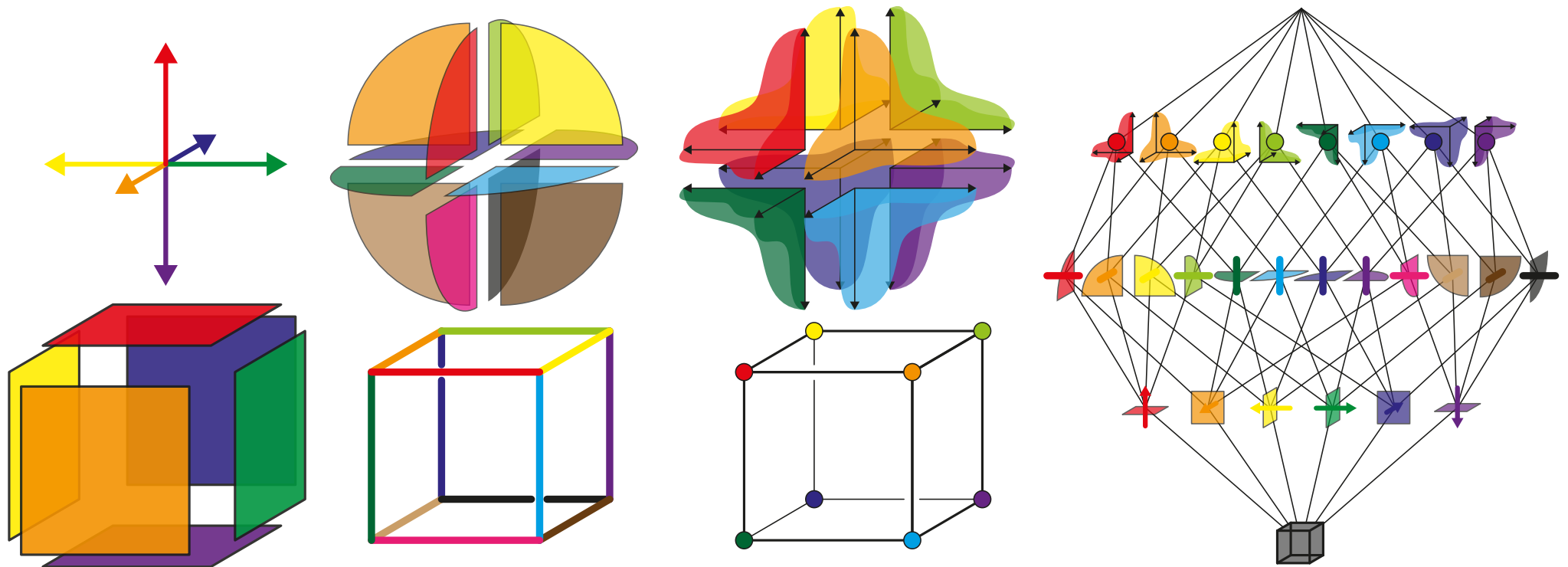

P polytope, F face of P

normal cone of F = positive span of the outer normal vectors of the facets containing F

normal fan of P = $\{ \text{normal cone of } F \mid F \text{ face of } P \}$

simple polytope \implies simplicial fan \implies simplicial complex

G-VECTORS & C-VECTORS

multiplicity vector \mathbf{m}_V of multiset $V = \{\{v_1, \dots, v_m\}\}$ of $Q_0 = \sum_{i \in [m]} e_{v_i} \in \mathbb{R}^{Q_0}$

g-vector $\mathbf{g}(\omega)$ of a walk $\omega = \mathbf{m}_{\text{peaks}(\omega)} - \mathbf{m}_{\text{deeps}(\omega)}$

c-vector $\mathbf{c}(\omega \in F)$ of a walk ω in a non-kissing facet $F = \varepsilon(\omega, F) \mathbf{m}_{\text{ds}(\omega, F)}$

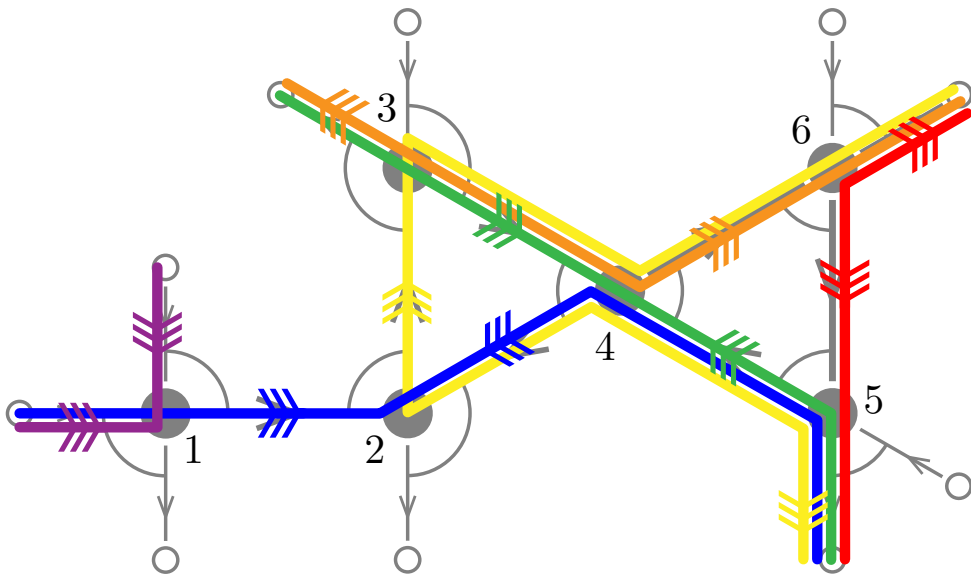

	●	●	●	●	●	●
1	0	0	0	0	0	-1
2	0	0	0	0	-1	0
3	0	1	0	1	0	0
4	0	0	0	-1	0	0
5	0	0	1	0	1	0
6	1	0	0	0	0	0

$\mathbf{g}(F)$

	●	●	●	●	●	●
1	0	0	0	0	0	-1
2	0	0	1	0	-1	0
3	0	1	0	0	0	0
4	0	1	1	-1	0	0
5	0	0	1	0	0	0
6	1	0	0	0	0	0

$\mathbf{c}(F)$

G-VECTORS & C-VECTORS

multiplicity vector \mathbf{m}_V of multiset $V = \{\{v_1, \dots, v_m\}\}$ of $Q_0 = \sum_{i \in [m]} \mathbf{e}_{v_i} \in \mathbb{R}^{Q_0}$

g-vector $\mathbf{g}(\omega)$ of a walk $\omega = \mathbf{m}_{\text{peaks}(\omega)} - \mathbf{m}_{\text{deeps}(\omega)}$

c-vector $\mathbf{c}(\omega \in F)$ of a walk ω in a non-kissing facet $F = \varepsilon(\omega, F) \mathbf{m}_{\text{ds}(\omega, F)}$

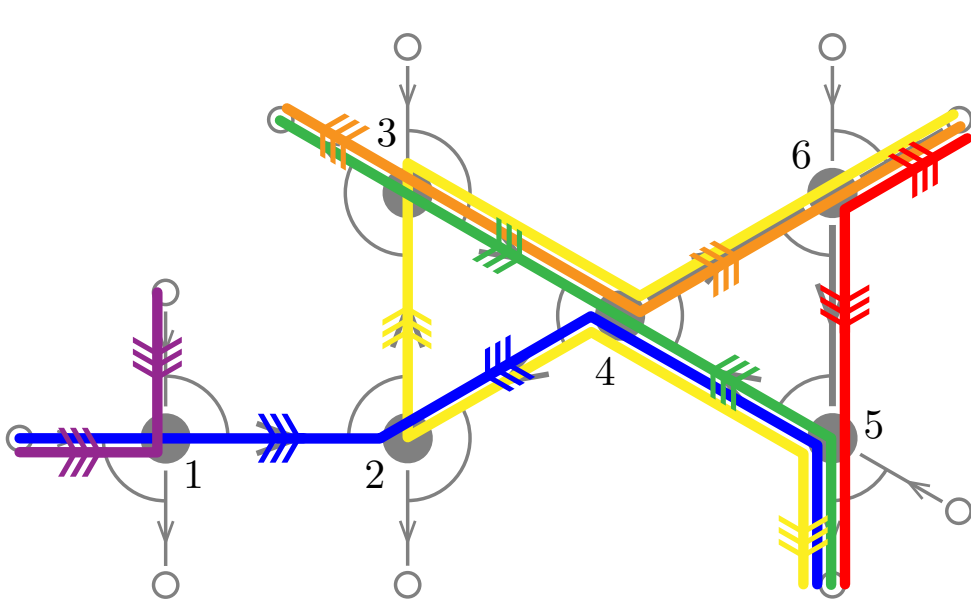

	●	●	●	●	●	●
1	0	0	0	0	0	-1
2	0	0	0	0	-1	0
3	0	1	0	1	0	0
4	0	0	0	-1	0	0
5	0	0	1	0	1	0
6	1	0	0	0	0	0

$\mathbf{g}(F)$

	●	●	●	●	●	●
1	0	0	0	0	0	-1
2	0	0	1	0	-1	0
3	0	1	0	0	0	0
4	0	1	1	-1	0	0
5	0	0	1	0	0	0
6	1	0	0	0	0	0

$\mathbf{c}(F)$

PROP. For any non-kissing facet F , the sets of vectors

$$\mathbf{g}(F) := \{\mathbf{g}(\omega) \mid \omega \in F\} \quad \text{and} \quad \mathbf{c}(F) := \{\mathbf{c}(\omega \in F) \mid \omega \in F\}$$

form dual bases.

G-VECTOR FAN

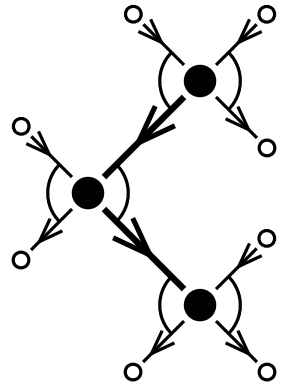

THM. For any gentle quiver \bar{Q} , the collection of cones

$$\mathcal{F}^g(\bar{Q}) := \{ \mathbb{R}_{\geq 0} \mathbf{g}(F) \mid F \in \mathcal{C}_{\text{nk}}(\bar{Q}) \}$$

forms a compl. simpl. fan, called g-vector fan of \bar{Q} .

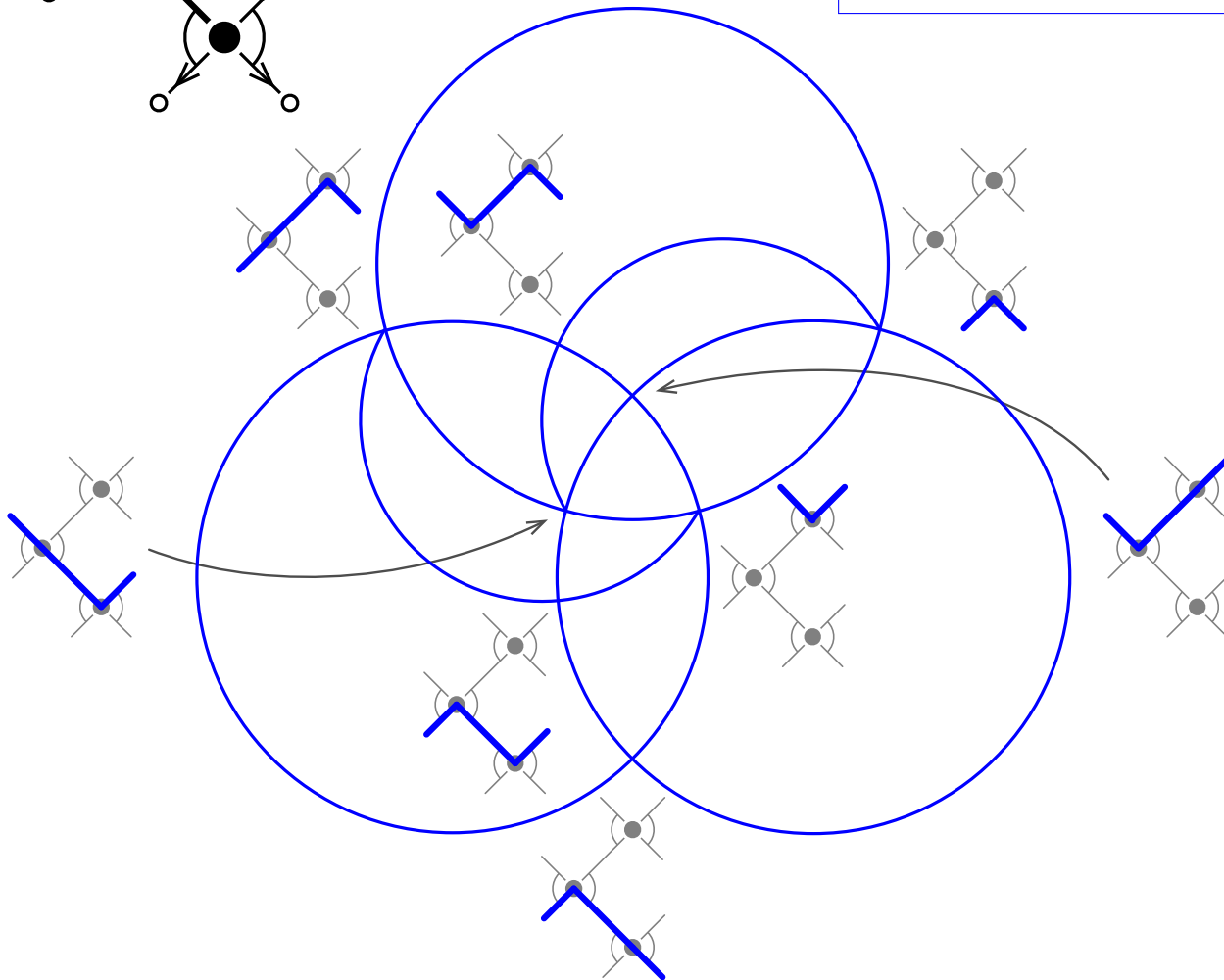

stereographic projection
from $(1, 1, 1)$

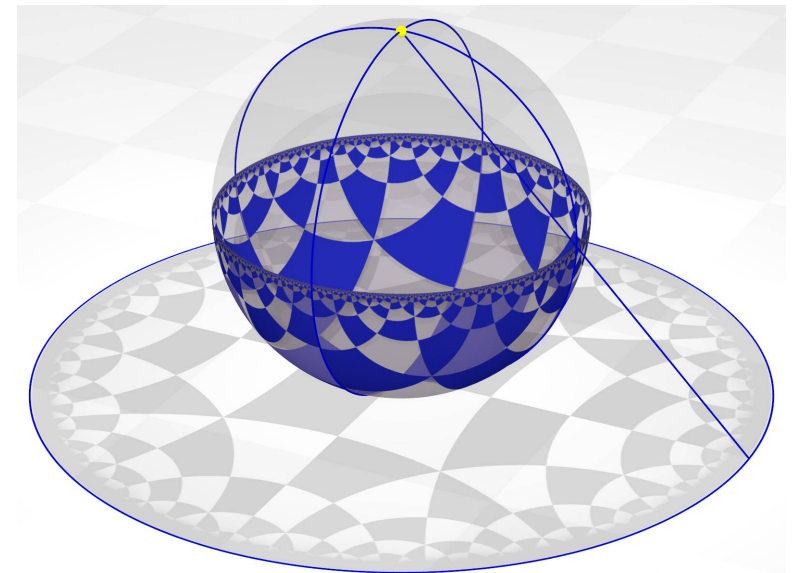

G -VECTOR FAN

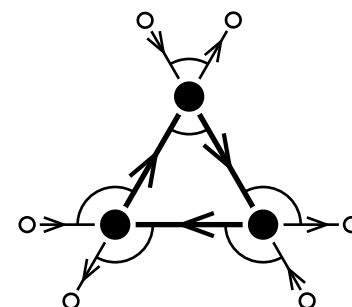
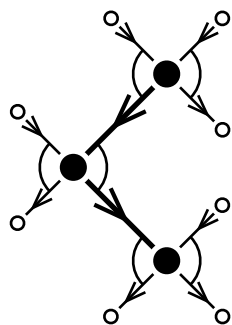
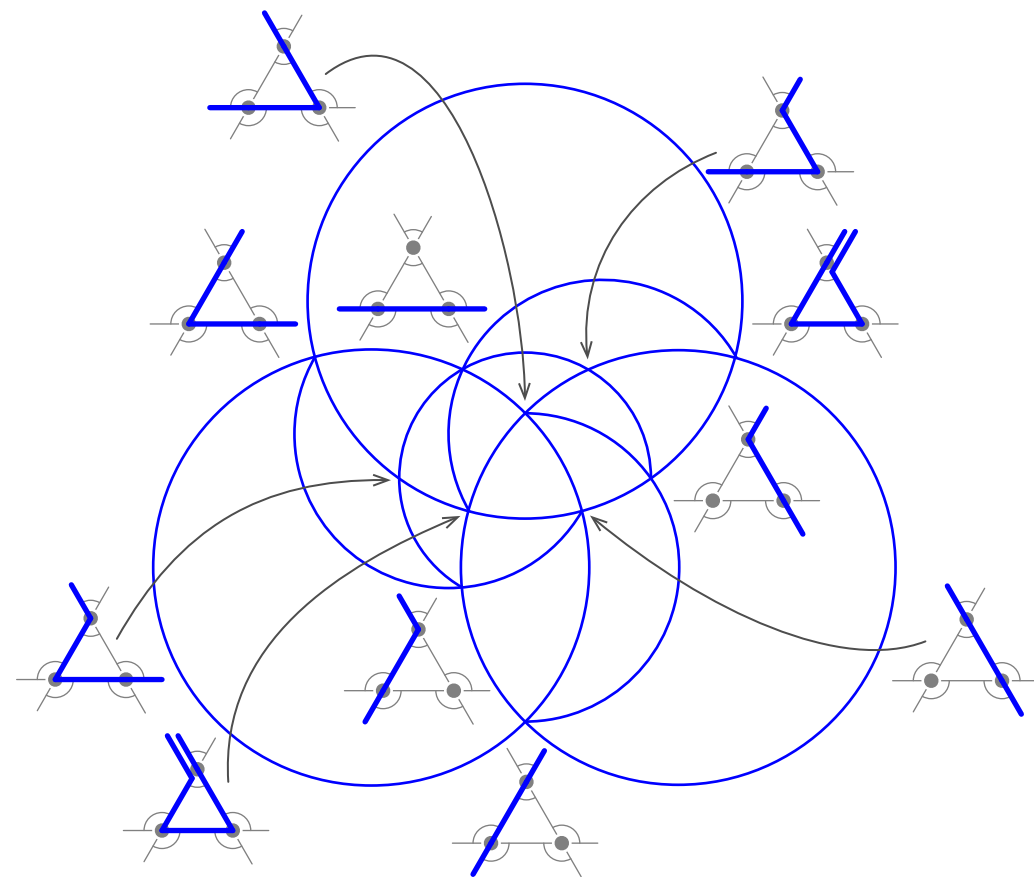
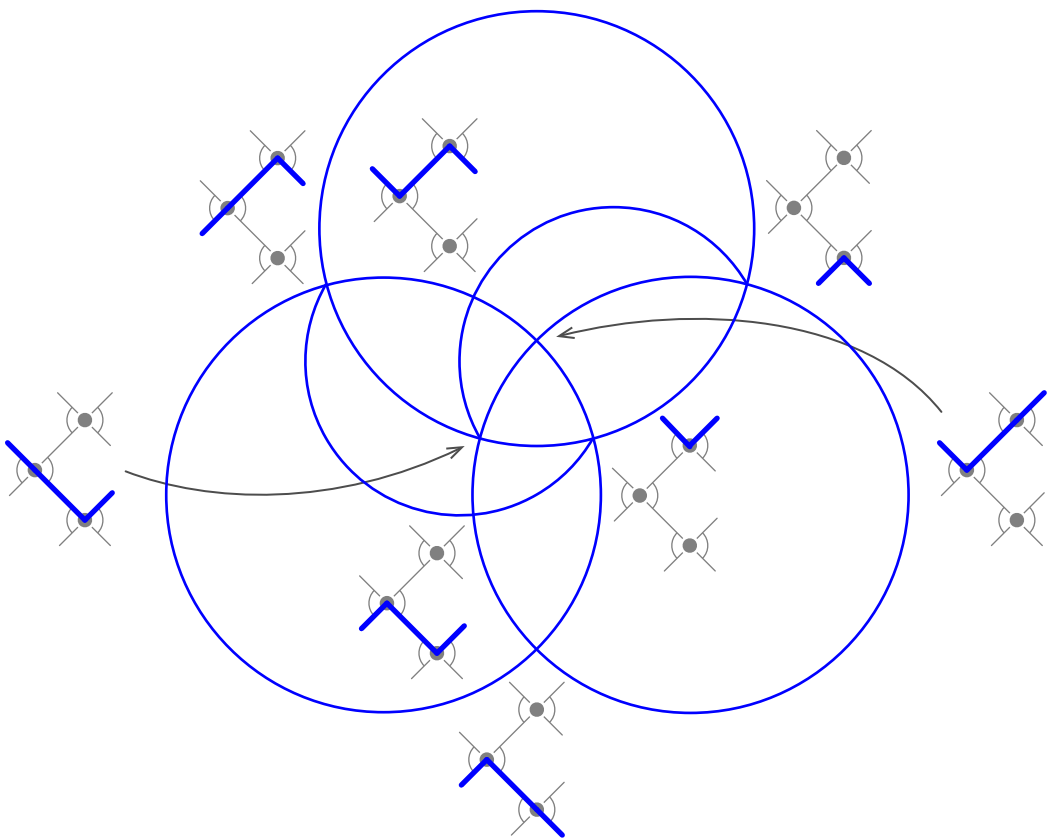

NON-KISSING ASSOCIAHEDRON

kissing number $\kappa(\omega, \omega')$ = number of times ω kisses ω'

kissing number $\text{kn}(\omega) = \sum_{\omega'} \kappa(\omega, \omega') + \kappa(\omega', \omega)$

THM. For a gentle quiver \bar{Q} with finite non-kissing complex $\mathcal{C}_{\text{nk}}(\bar{Q})$,

the two sets of \mathbb{R}^{Q_0} given by

(i) the convex hull of the points

$$\mathbf{p}(F) := \sum_{\omega \in F} \text{kn}(\omega) \mathbf{c}(\omega \in F),$$

for all non-kissing facets $F \in \mathcal{C}_{\text{nk}}(\bar{Q})$,

(ii) the intersection of the halfspaces

$$\mathbf{H}^{\geq}(\omega) := \{ \mathbf{x} \in \mathbb{R}^{Q_0} \mid \langle \mathbf{g}(\omega) \mid \mathbf{x} \rangle \leq \text{kn}(\omega) \}.$$

for all walks ω of \bar{Q} ,

define the same polytope, whose normal fan is the \mathbf{g} -vector fan $\mathcal{F}^{\mathbf{g}}$. We call it the \bar{Q} -associahedron and denote it by Asso .

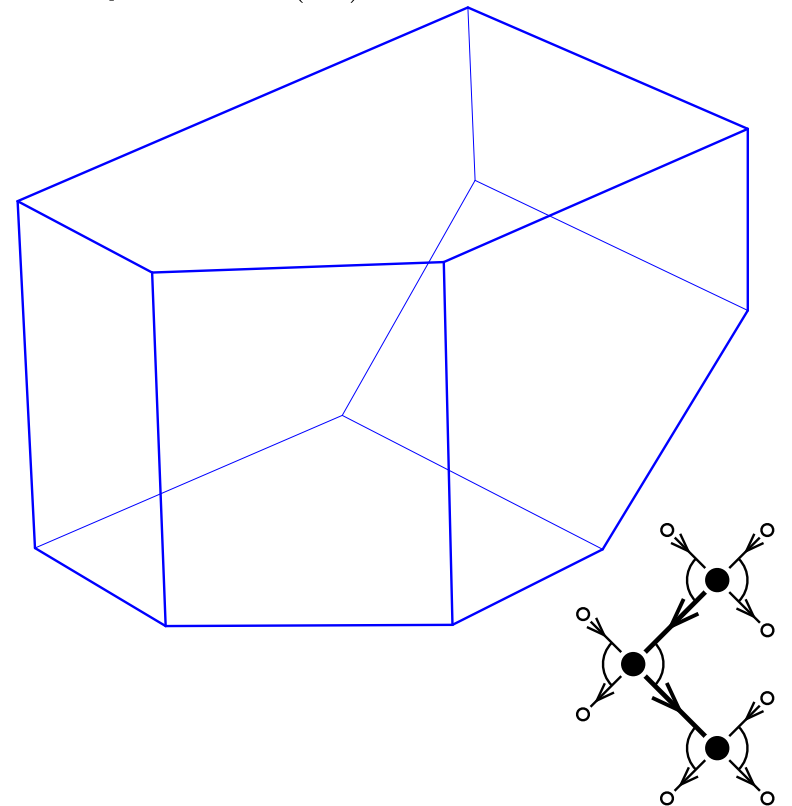

NON-KISSING ASSOCIAHEDRON

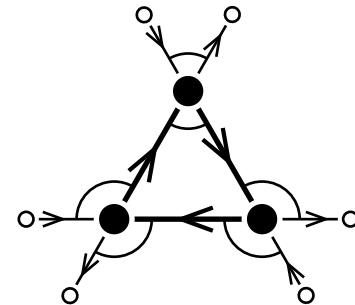
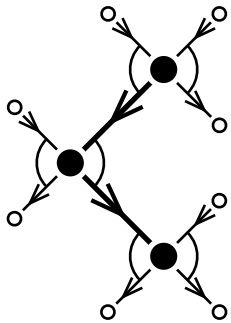
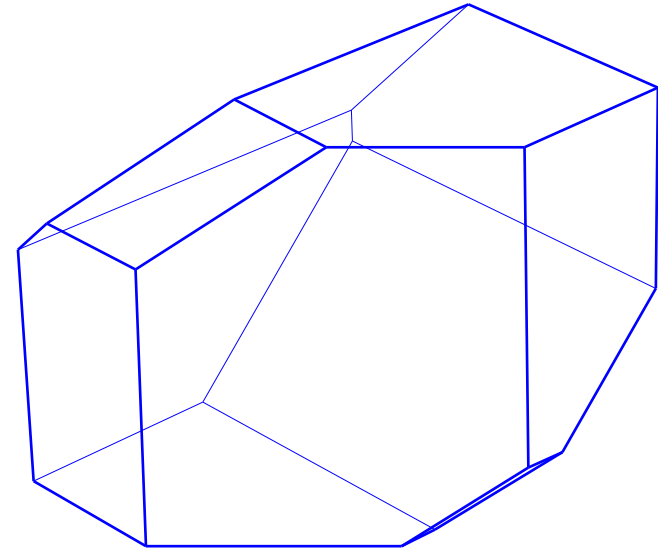
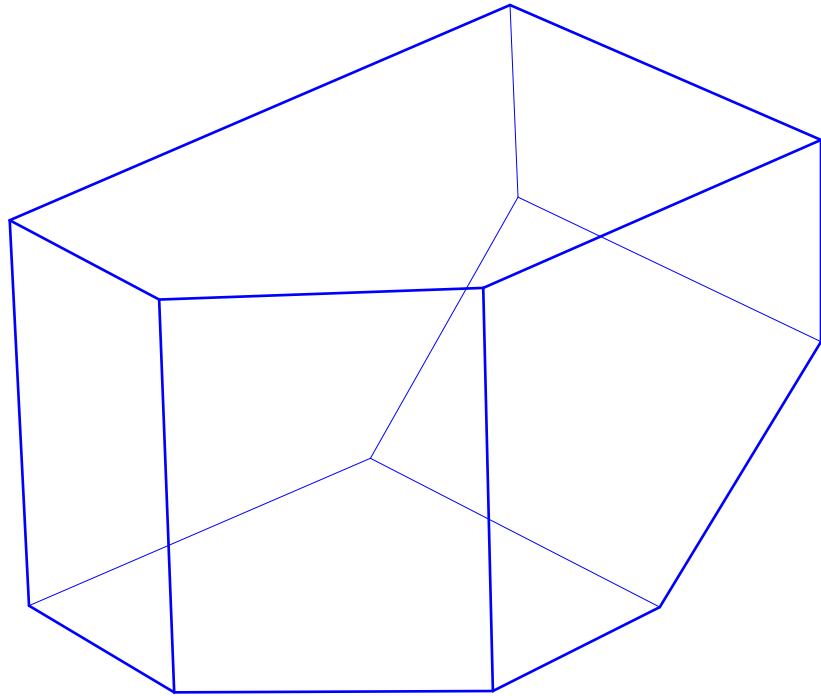

NON-KISSING ASSOCIAHEDRON VS ZONOTOPES

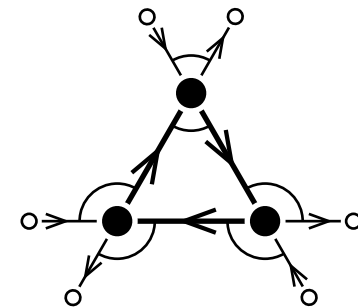
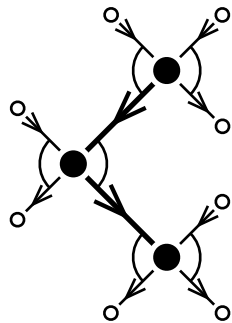
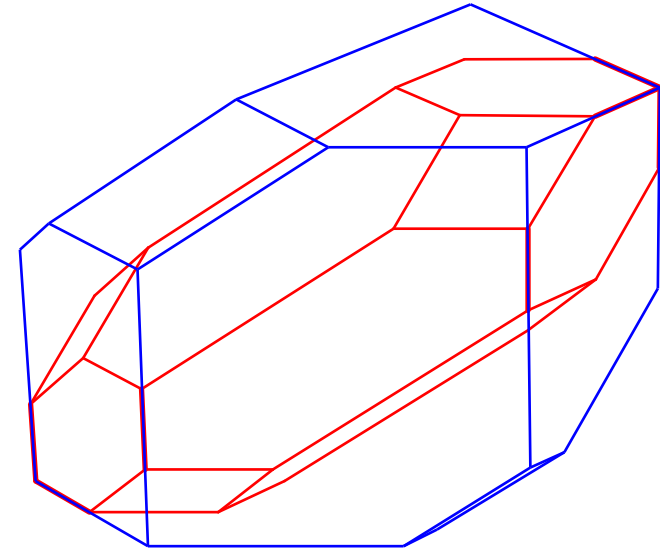
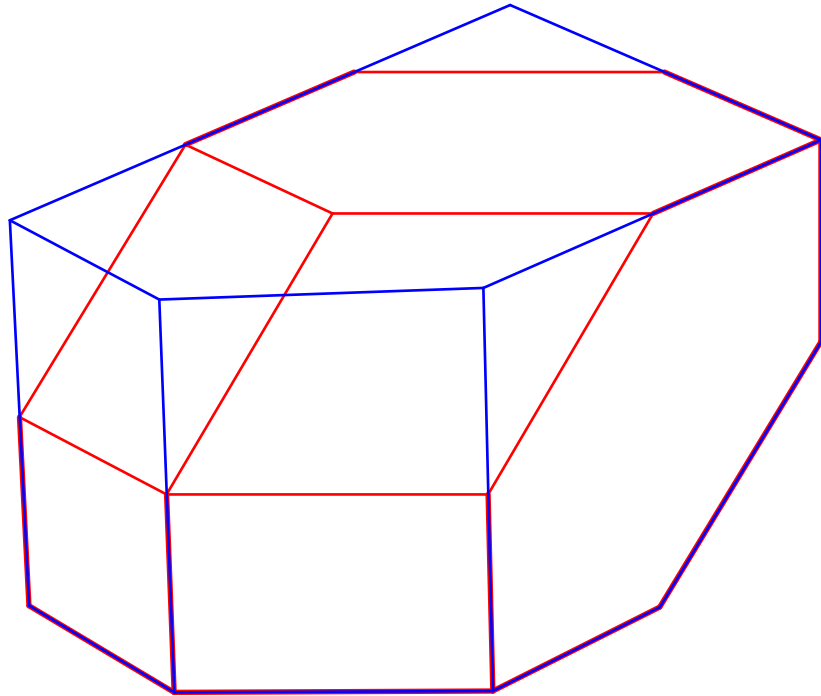

NON-KISSING LATTICE

NON-KISSING LATTICE

THM. For a gentle quiver \bar{Q} with finite non-kissing complex $\mathcal{C}_{\text{nk}}(\bar{Q})$, the non-kissing flip graph is the Hasse diagram of a congruence-uniform lattice.

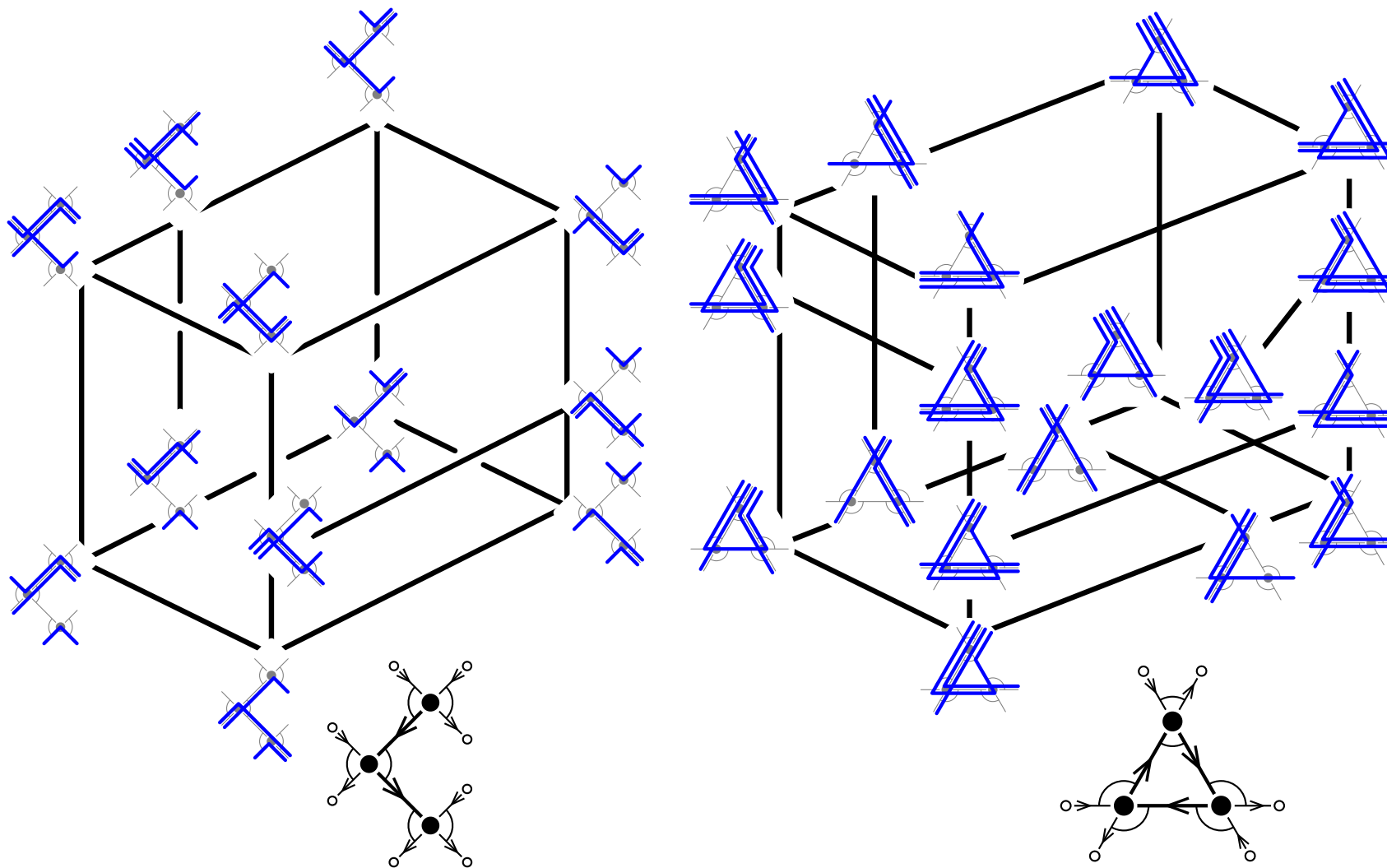

LATTICE QUOTIENTS

lattice = poset (L, \leq) with a meet \wedge and a join \vee

lattice congruence = equiv. rel. \equiv on L which respects meets and joins

$$x \equiv x' \quad \text{and} \quad y \equiv y' \quad \implies \quad x \wedge y \equiv x' \wedge y' \quad \text{and} \quad x \vee y \equiv x' \vee y'$$

lattice quotient of L/\equiv = lattice on equiv. classes of L under \equiv where

- $X \leq Y \iff \exists x \in X, y \in Y, x \leq y$
- $X \wedge Y$ = equiv. class of $x \wedge y$ for any $x \in X$ and $y \in Y$
- $X \vee Y$ = equiv. class of $x \vee y$ for any $x \in X$ and $y \in Y$

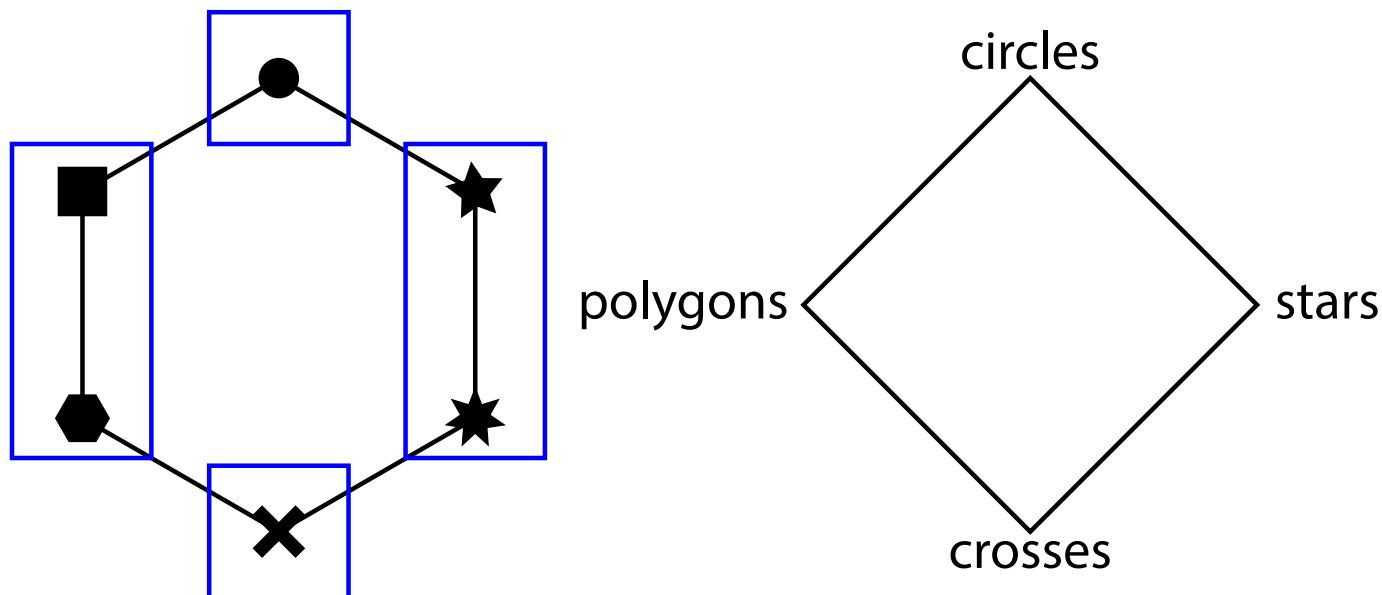

EXM: TAMARI LATTICE AS LATTICE QUOTIENT OF WEAK ORDER

binary search tree insertion of 2751346

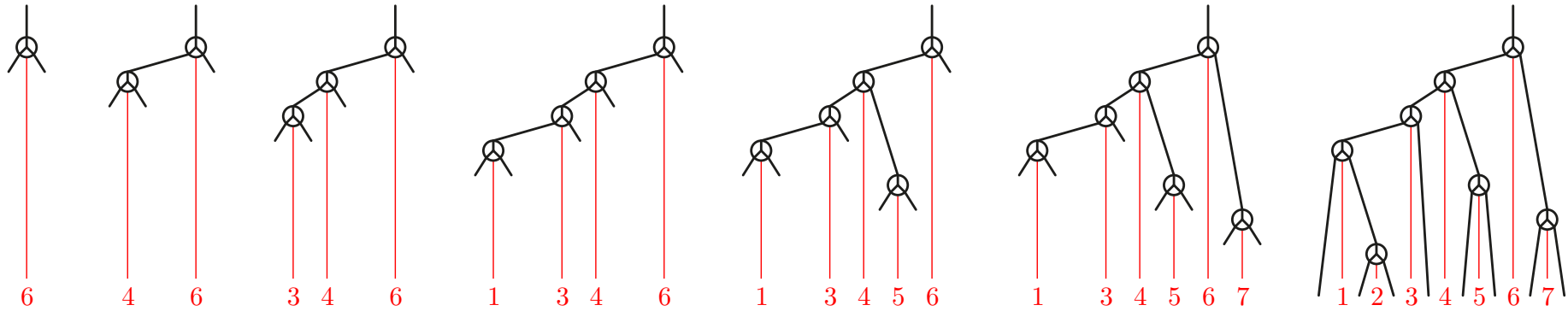

EXM: TAMARI LATTICE AS LATTICE QUOTIENT OF WEAK ORDER

binary search tree insertion of 2751346

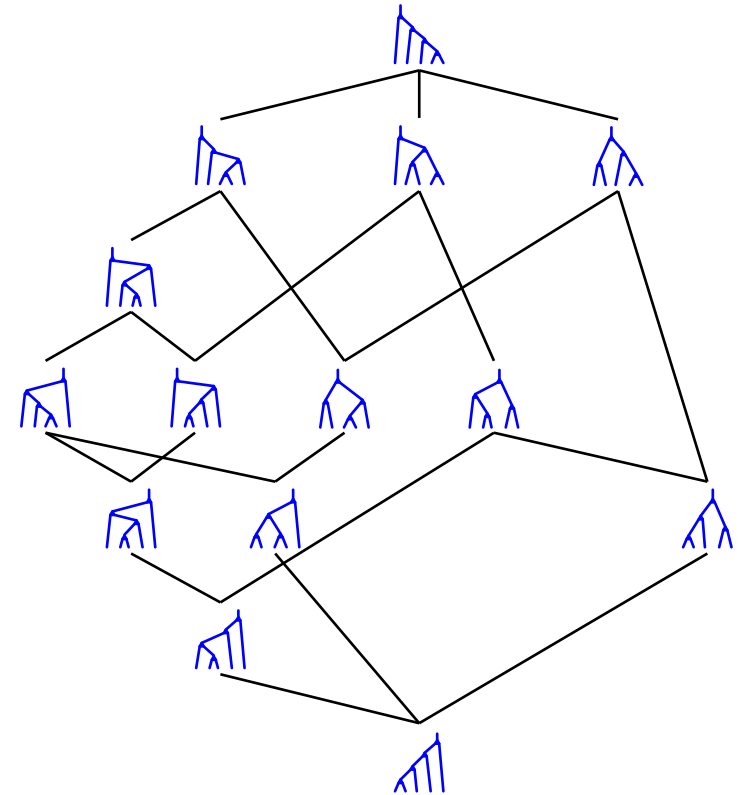
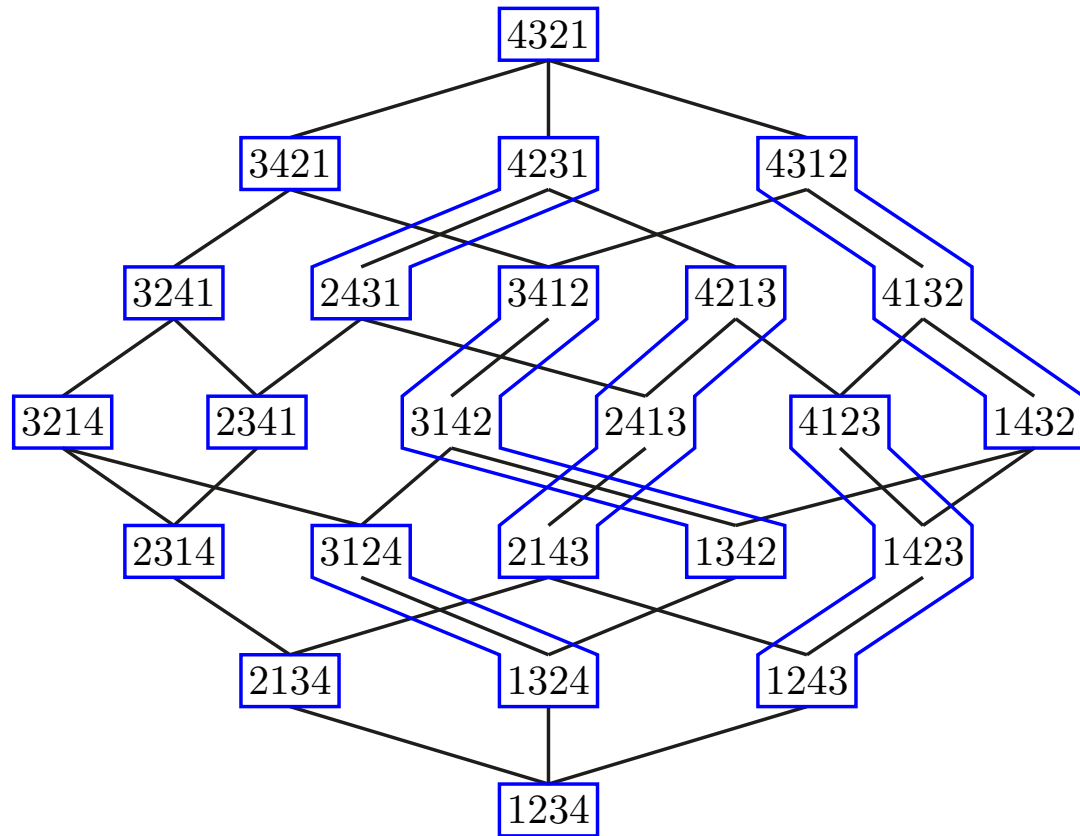
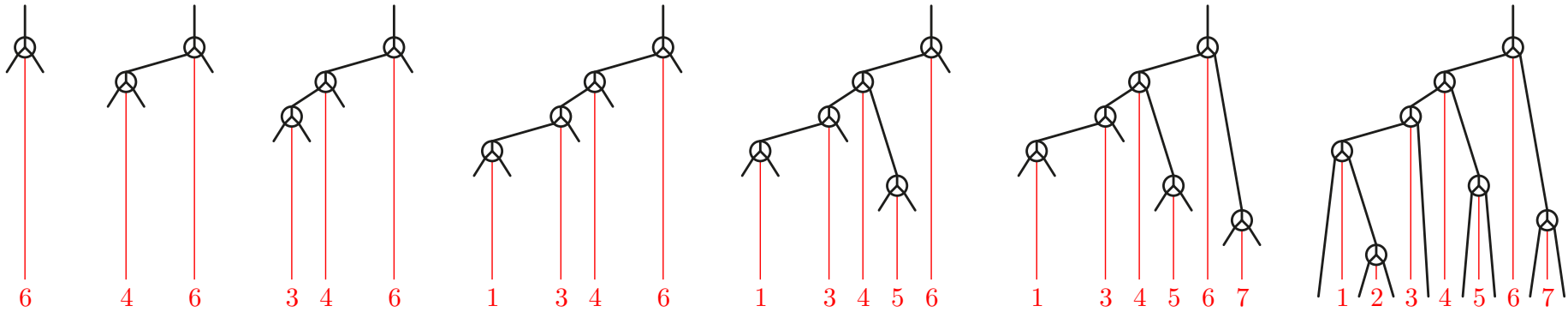

BICLOSED SETS OF SEGMENTS

σ, τ oriented strings

concatenation $\sigma \circ \tau = \{ \sigma \alpha \tau \mid \alpha \in Q_1 \text{ and } \sigma \alpha \tau \text{ string of } \bar{Q} \}$

closure $S^{\text{cl}} = \bigcup_{\substack{\ell \in \mathbb{N} \\ \sigma_1, \dots, \sigma_\ell \in S}} \sigma_1 \circ \dots \circ \sigma_\ell =$ all strings obtained by concatenation of some strings of S

closed $\iff S^{\text{cl}} = S$

coclosed $\iff \bar{S}^{\text{cl}} = \bar{S}$

biclosed = closed and coclosed

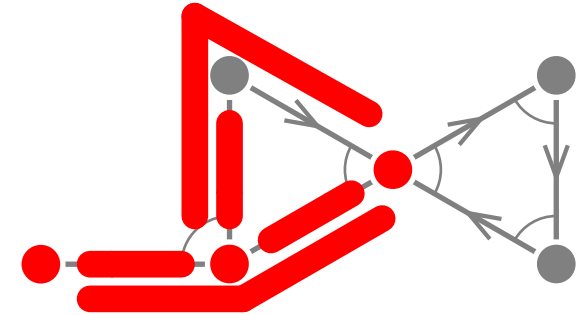
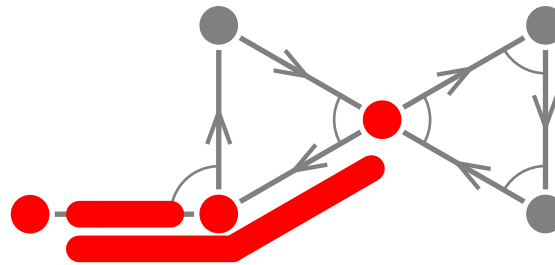
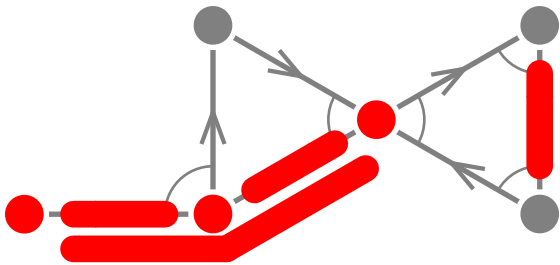

THM. For any gentle quiver \bar{Q} such that $\mathcal{K}_{\text{nk}}(\bar{Q})$ is finite, the inclusion poset on biclosed sets of strings of \bar{Q} is a congruence-uniform lattice.

NON-KISSING INSERTION

Surjection from biclosed sets of strings to non-kissing facets

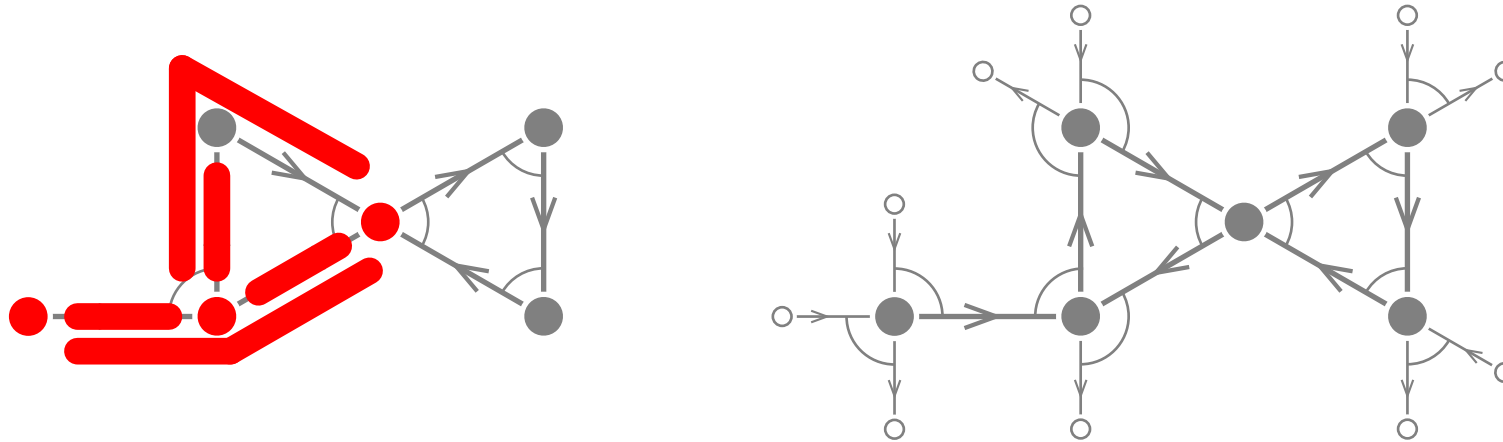

S biclosed, $\alpha \in Q_1$

$\omega(\alpha, S) =$ walk constructed with the local rules:

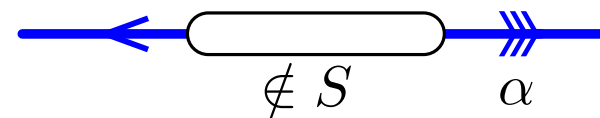
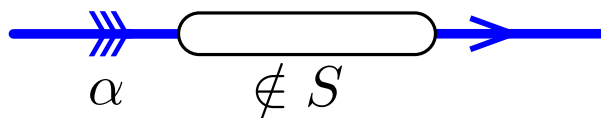
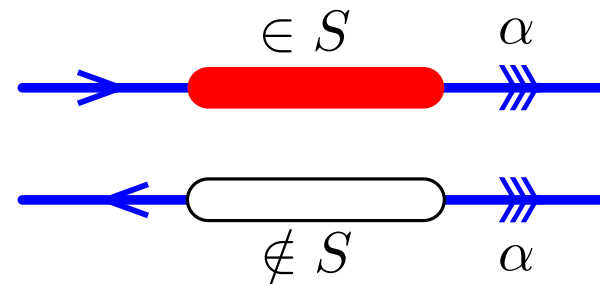
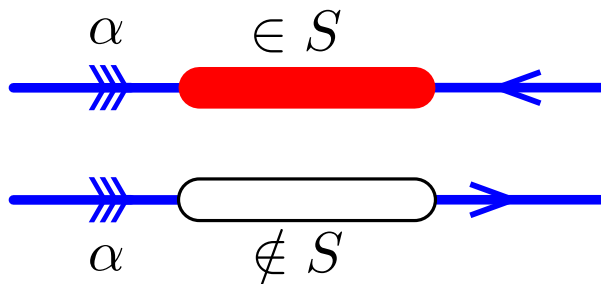

NON-KISSING INSERTION

Surjection from biclosed sets of strings to non-kissing facets

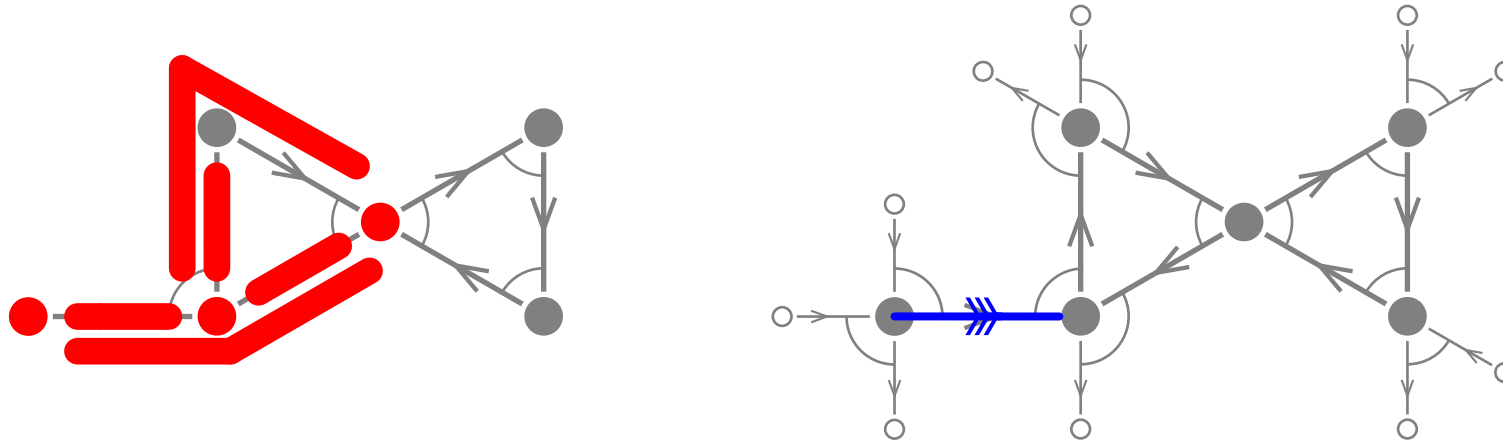

S biclosed, $\alpha \in Q_1$

$\omega(\alpha, S) =$ walk constructed with the local rules:

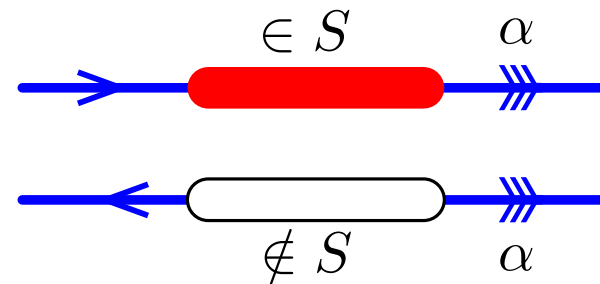
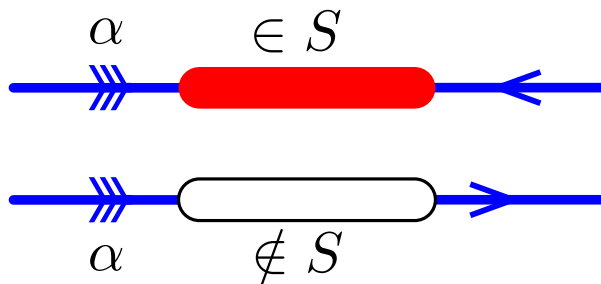

NON-KISSING INSERTION

Surjection from biclosed sets of strings to non-kissing facets

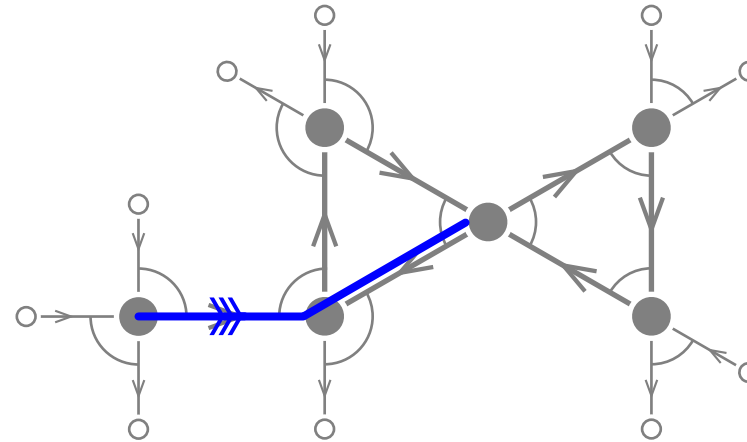
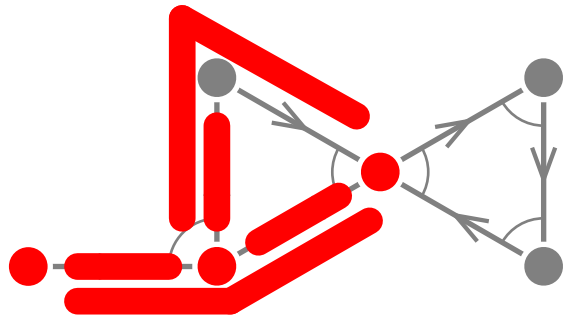

S biclosed, $\alpha \in Q_1$

$\omega(\alpha, S) =$ walk constructed with the local rules:

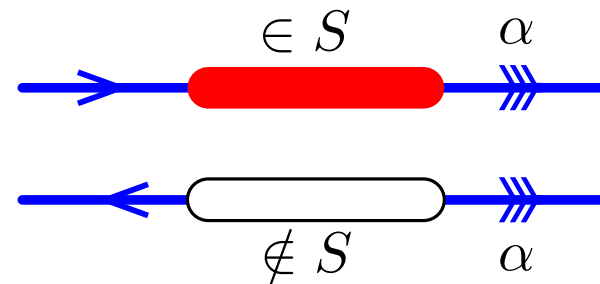
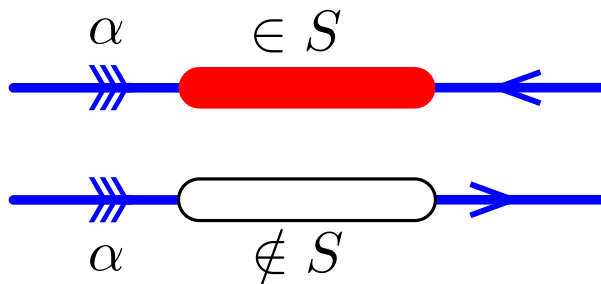

NON-KISSING INSERTION

Surjection from biclosed sets of strings to non-kissing facets

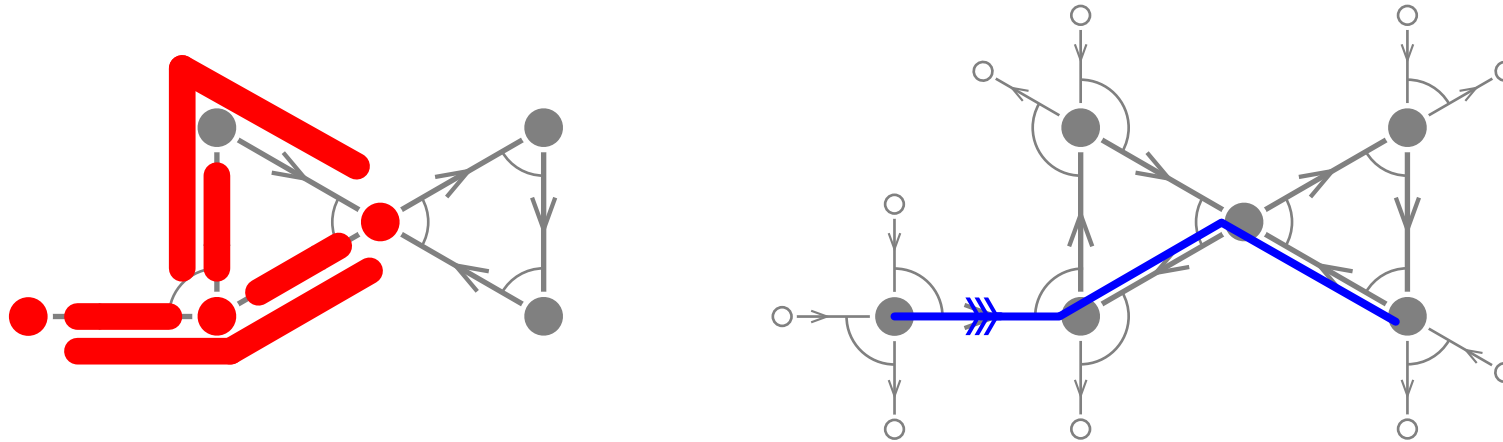

S biclosed, $\alpha \in Q_1$

$\omega(\alpha, S) =$ walk constructed with the local rules:

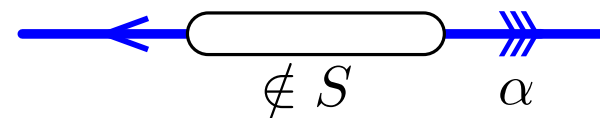
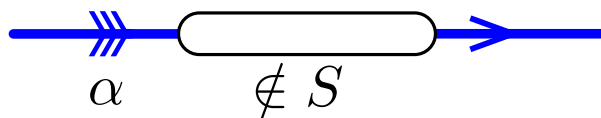
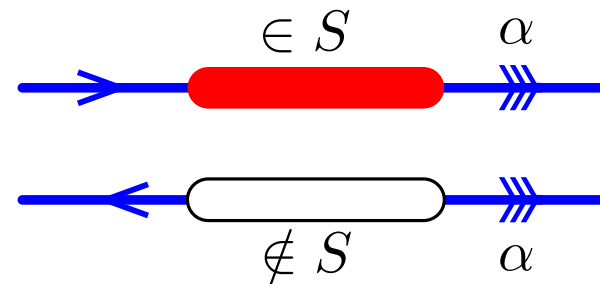
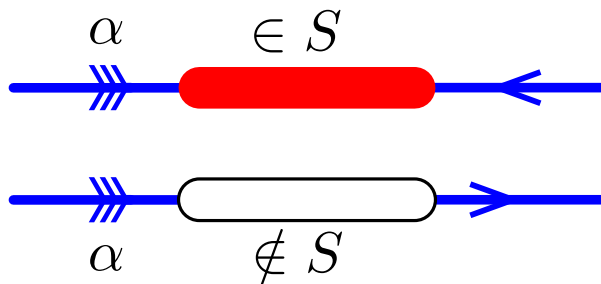

NON-KISSING INSERTION

Surjection from biclosed sets of strings to non-kissing facets

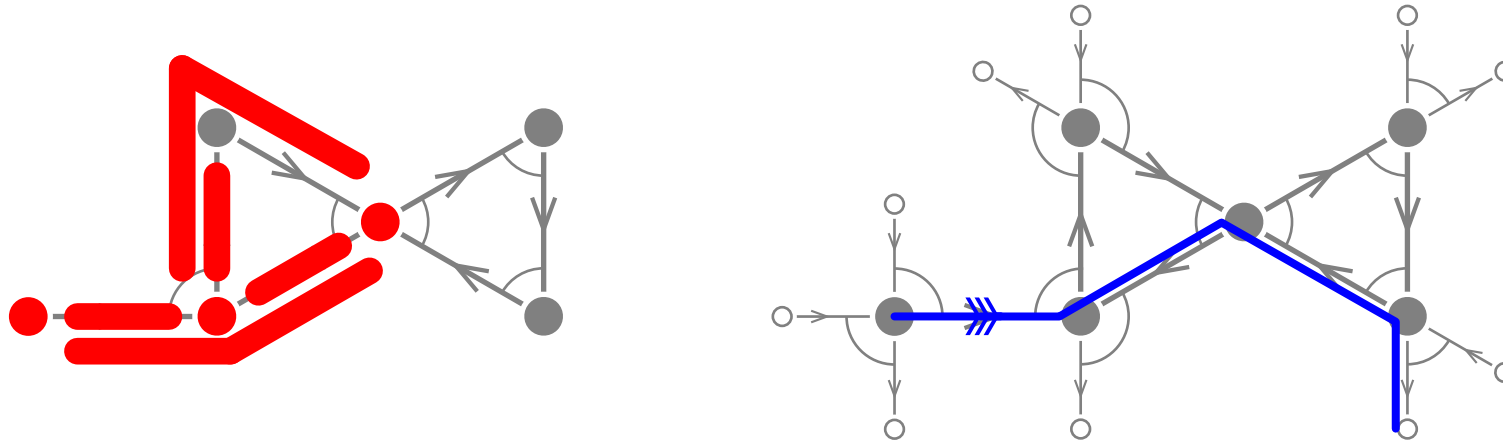

S biclosed, $\alpha \in Q_1$

$\omega(\alpha, S)$ = walk constructed with the local rules:

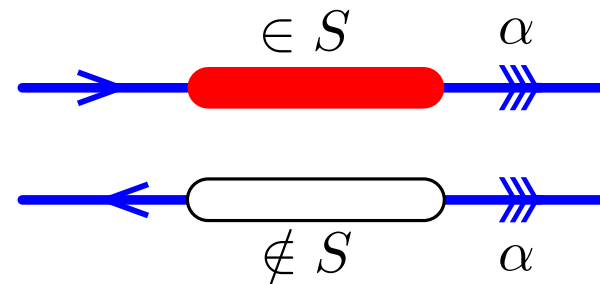
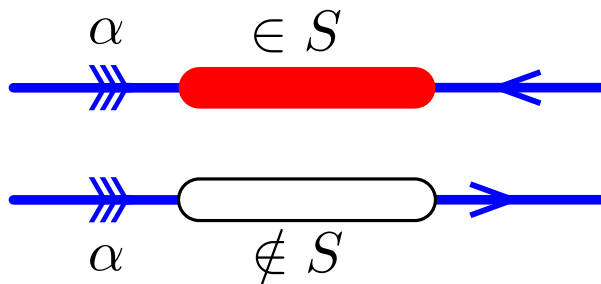

NON-KISSING INSERTION

Surjection from biclosed sets of strings to non-kissing facets

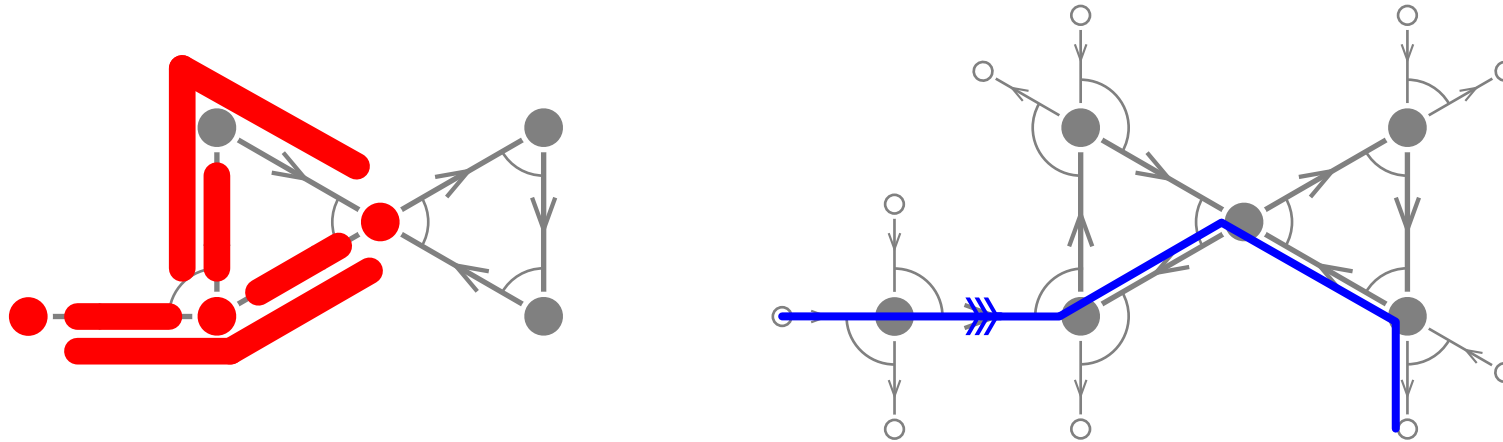

S biclosed, $\alpha \in Q_1$

$\omega(\alpha, S) =$ walk constructed with the local rules:

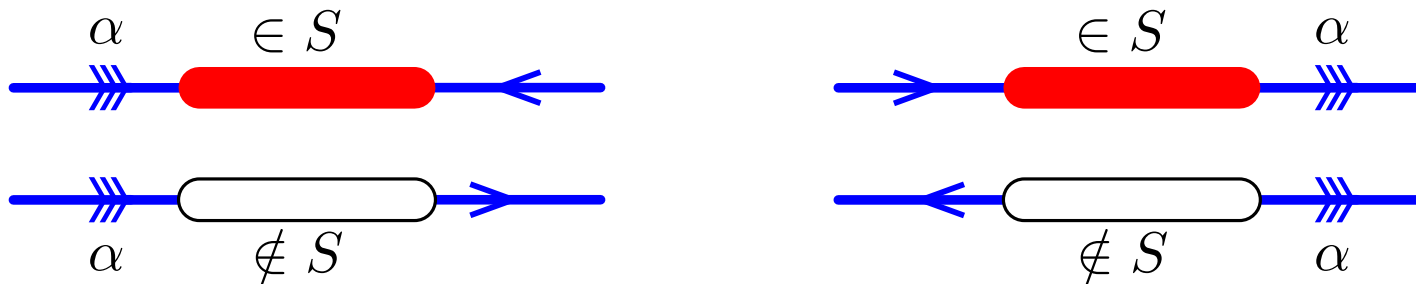

NON-KISSING INSERTION

Surjection from biclosed sets of strings to non-kissing facets

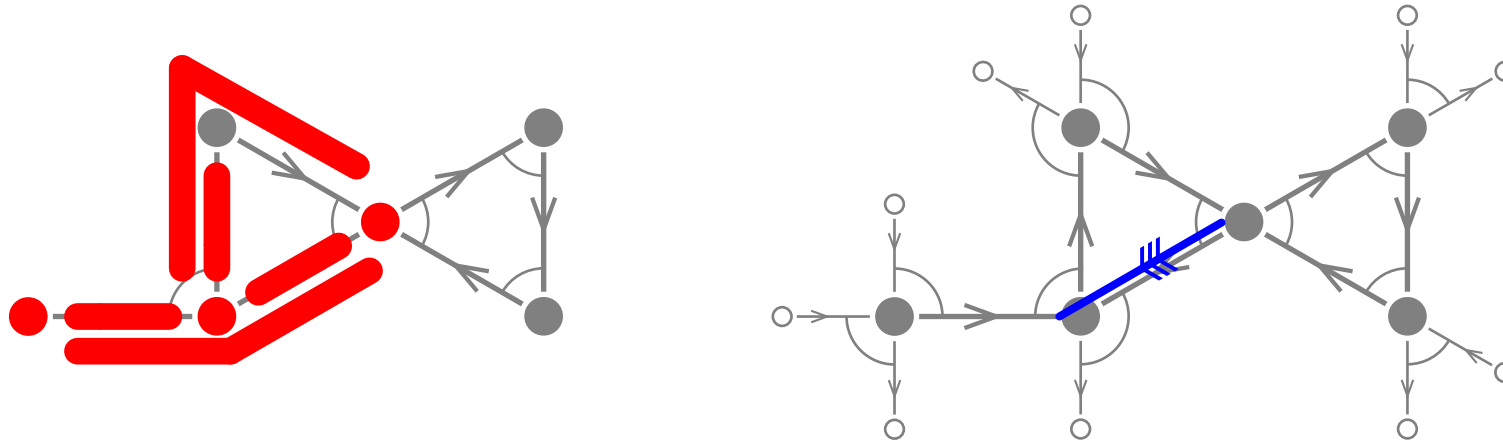

S biclosed, $\alpha \in Q_1$

$\omega(\alpha, S) =$ walk constructed with the local rules:

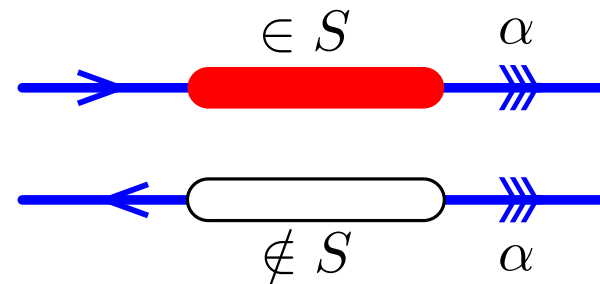
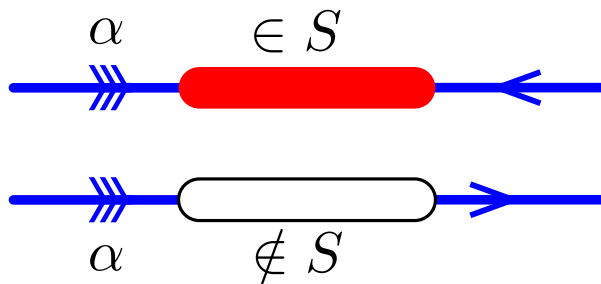

NON-KISSING INSERTION

Surjection from biclosed sets of strings to non-kissing facets

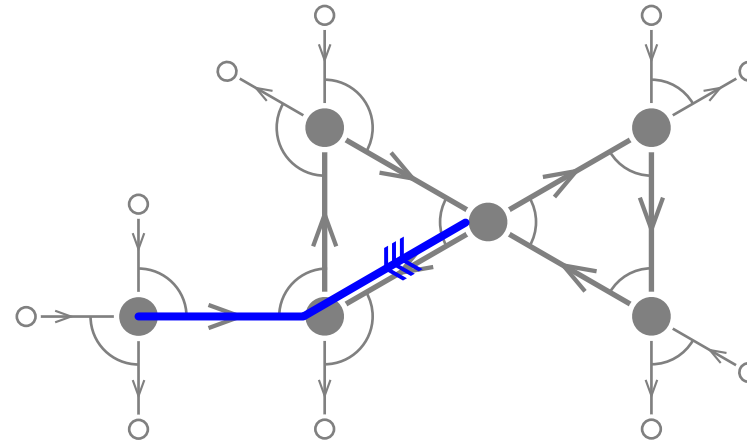
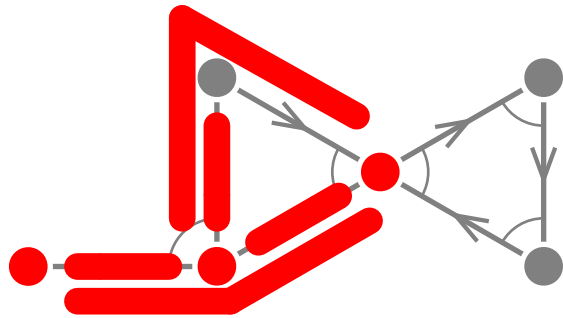

S biclosed, $\alpha \in Q_1$

$\omega(\alpha, S) =$ walk constructed with the local rules:

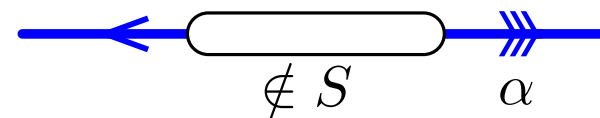
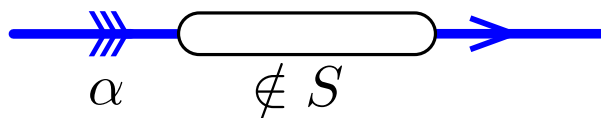
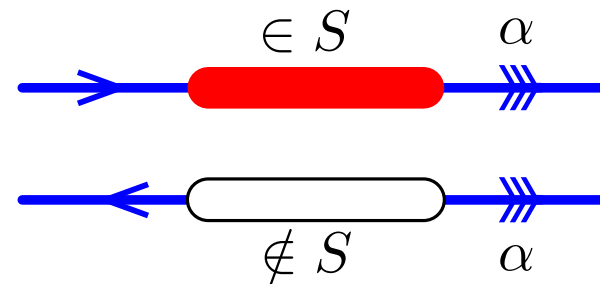
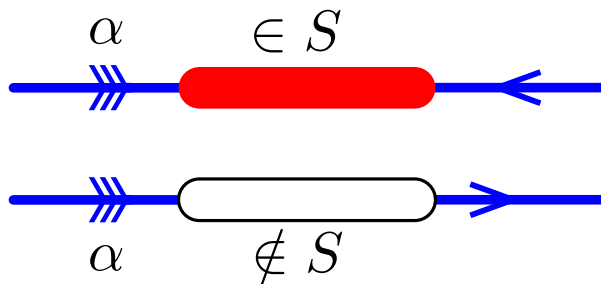

NON-KISSING INSERTION

Surjection from biclosed sets of strings to non-kissing facets

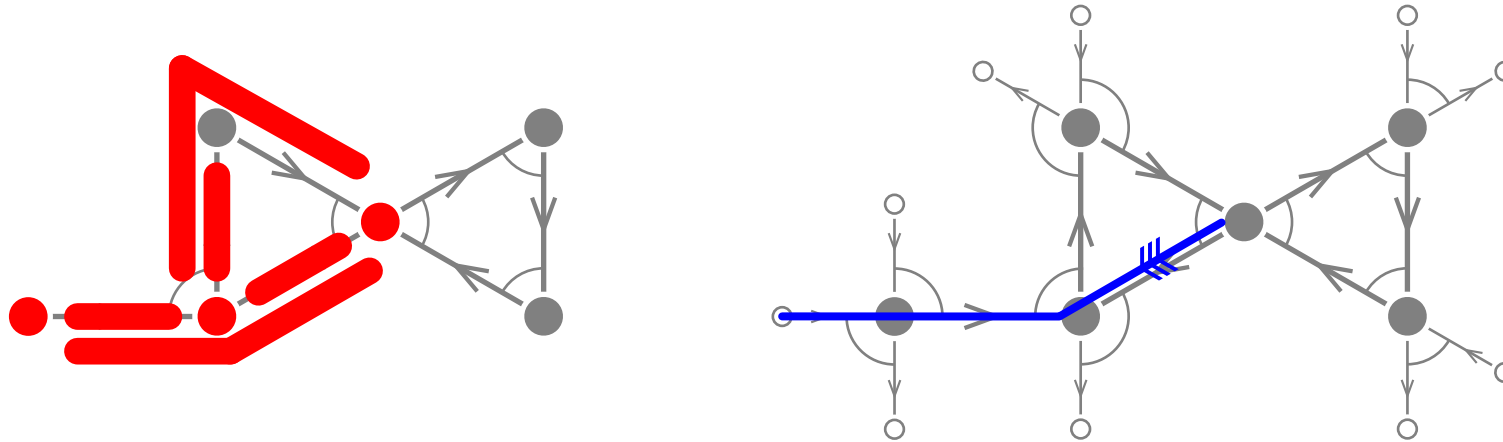

S biclosed, $\alpha \in Q_1$

$\omega(\alpha, S) =$ walk constructed with the local rules:

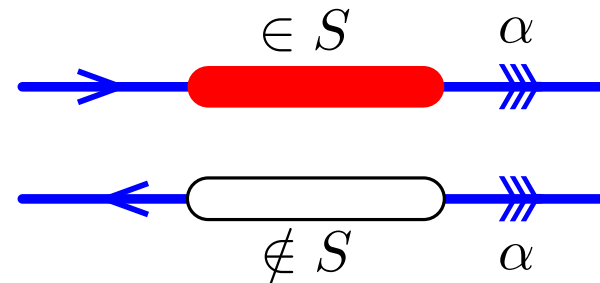
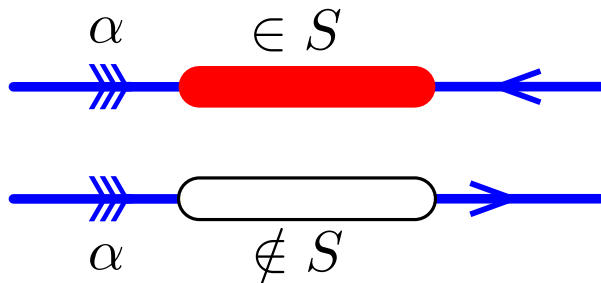

NON-KISSING INSERTION

Surjection from biclosed sets of strings to non-kissing facets

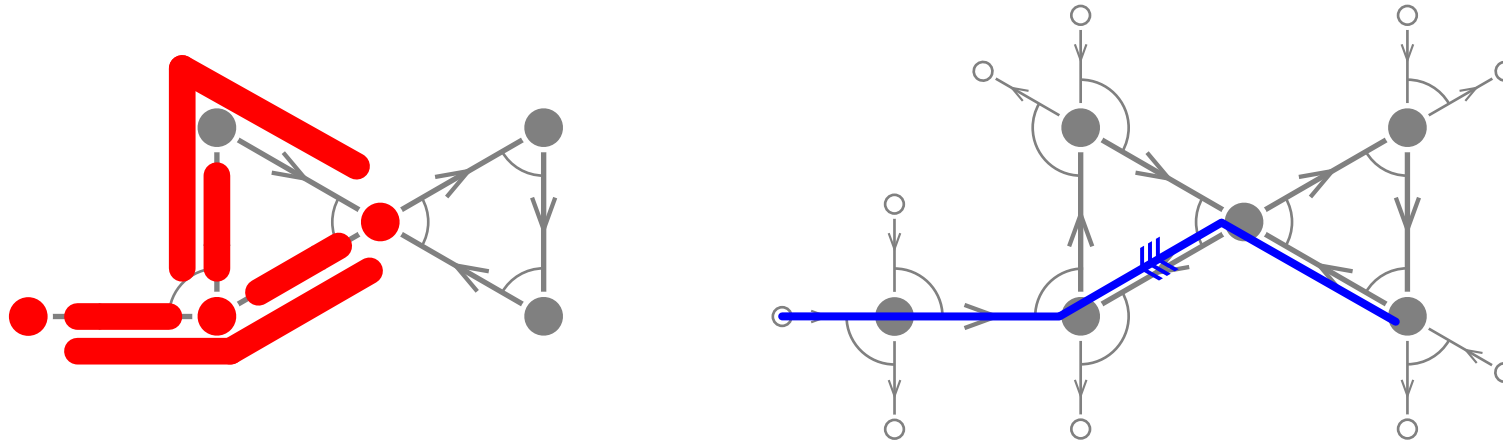

S biclosed, $\alpha \in Q_1$

$\omega(\alpha, S) =$ walk constructed with the local rules:

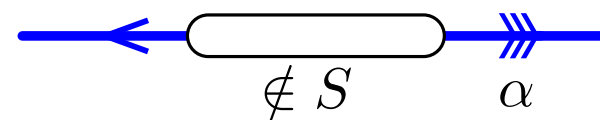
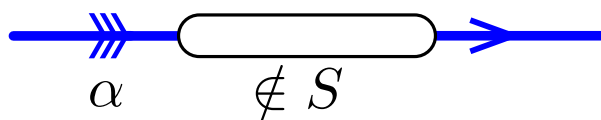
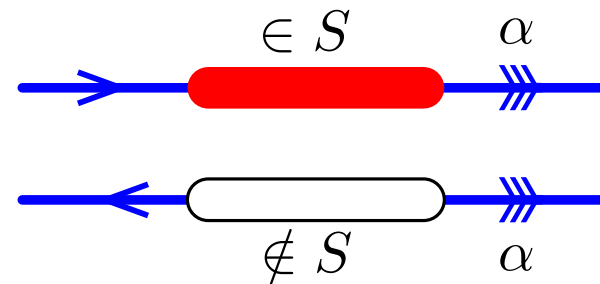
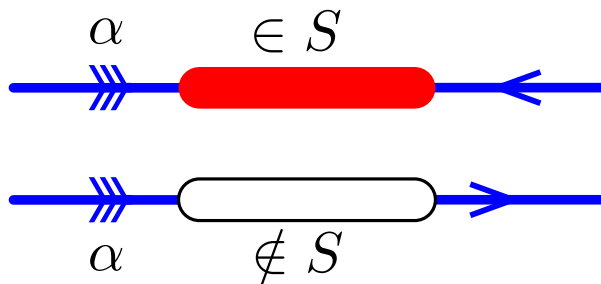

NON-KISSING INSERTION

Surjection from biclosed sets of strings to non-kissing facets

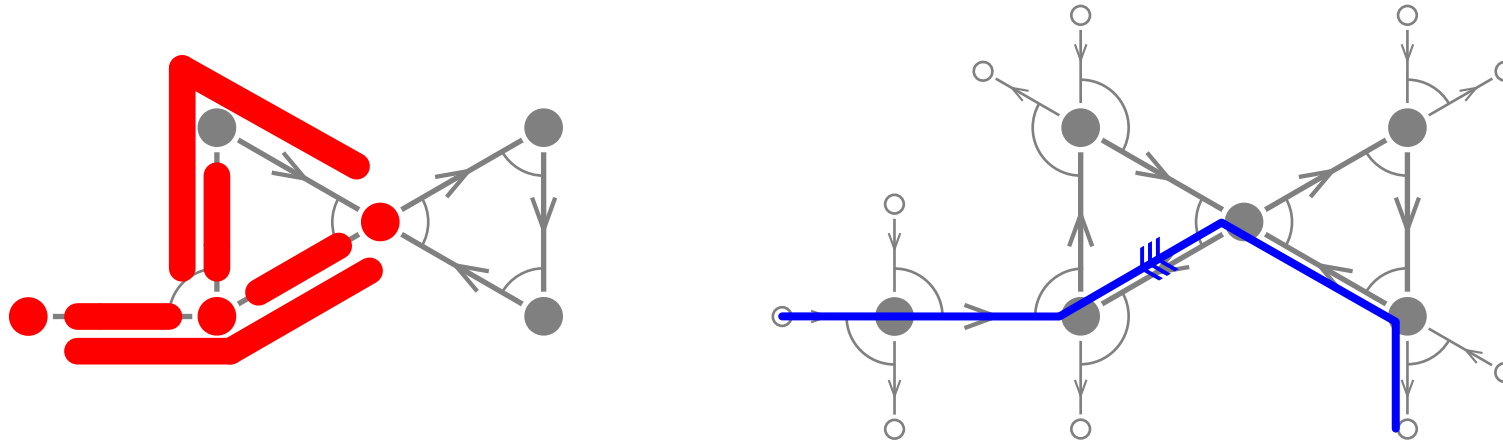

S biclosed, $\alpha \in Q_1$

$\omega(\alpha, S)$ = walk constructed with the local rules:

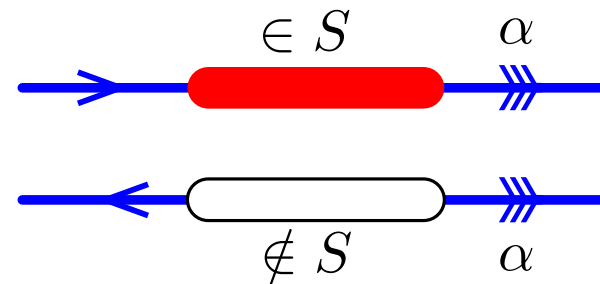
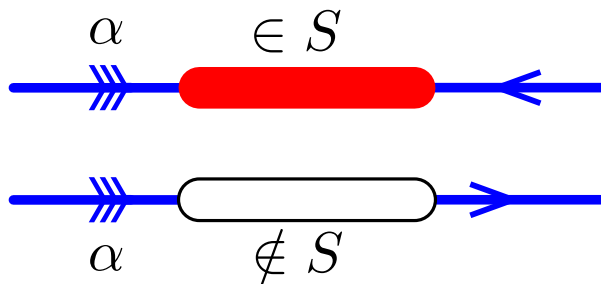

NON-KISSING INSERTION

Surjection from biclosed sets of strings to non-kissing facets

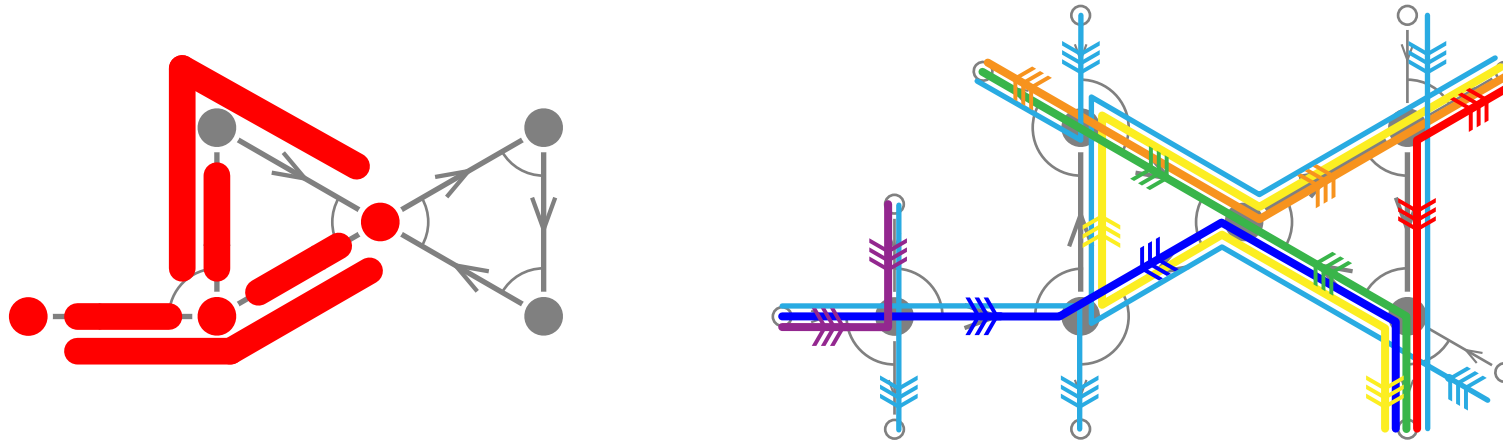

PROP. $\eta(S) := \{\omega(\alpha, S) \mid \alpha \in Q_1\}$ is a non-kissing facet.

EXM: BINARY SEARCH TREE INSERTION AGAIN

inversion set of 2751346

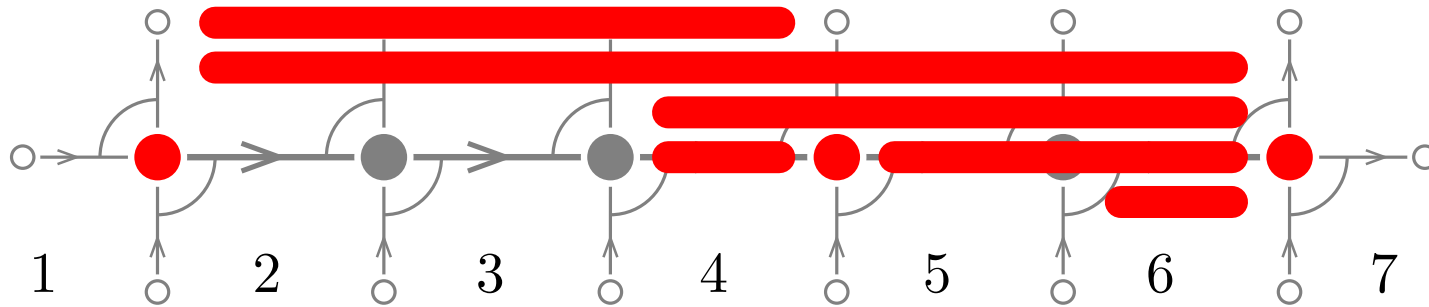

EXM: BINARY SEARCH TREE INSERTION AGAIN

inversion set of 2751346

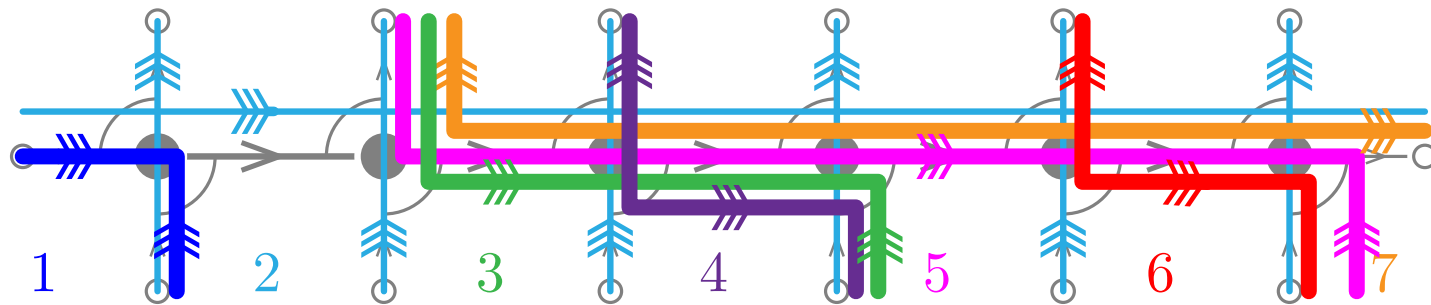
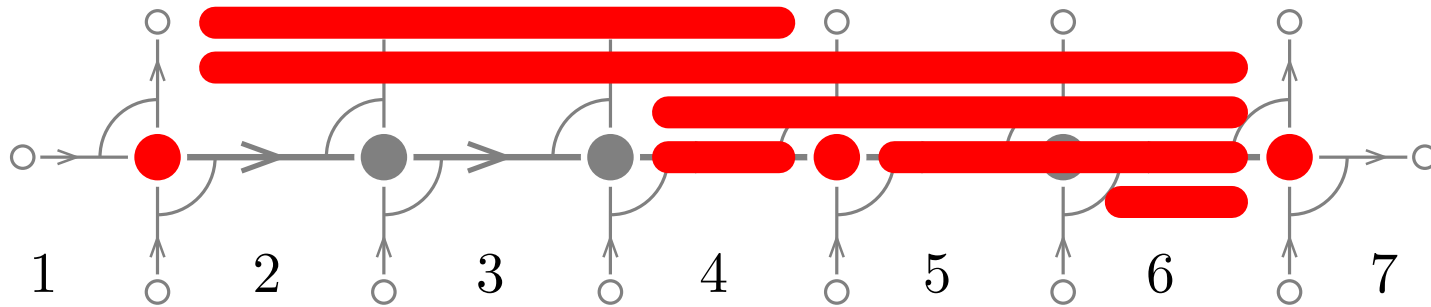

EXM: BINARY SEARCH TREE INSERTION AGAIN

inversion set of 2751346

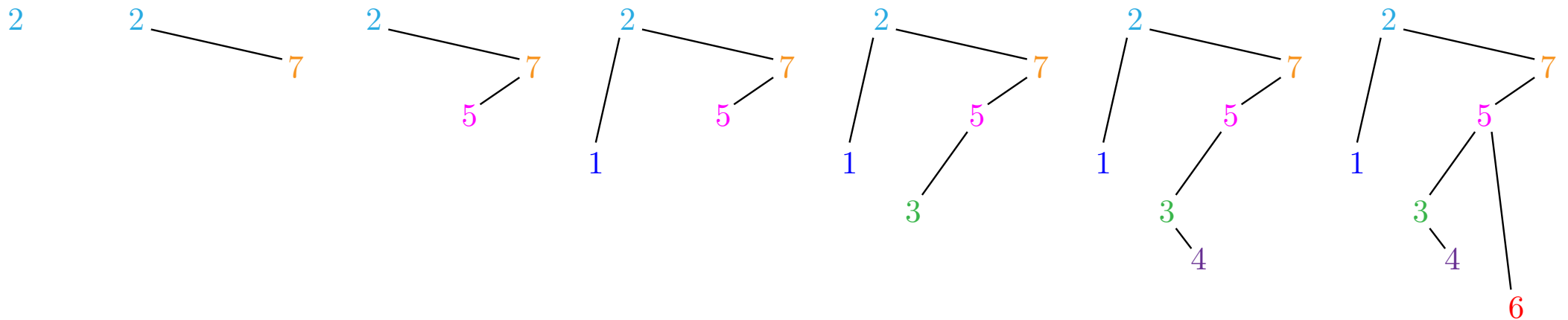
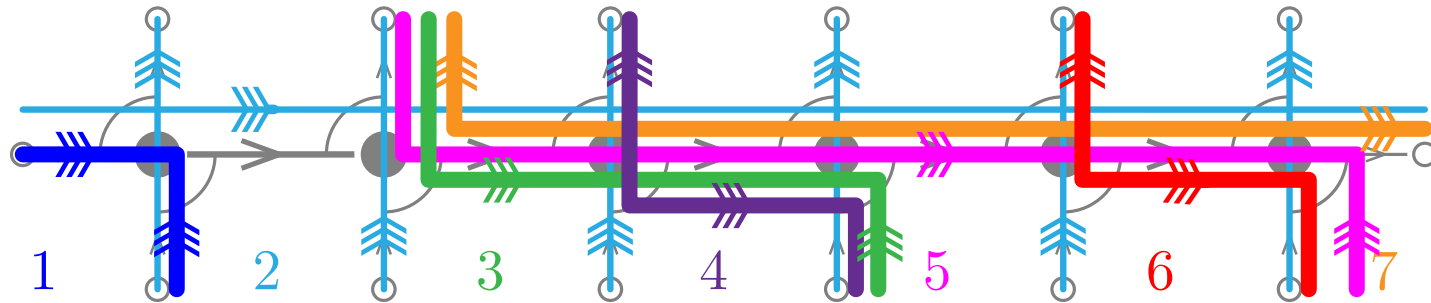
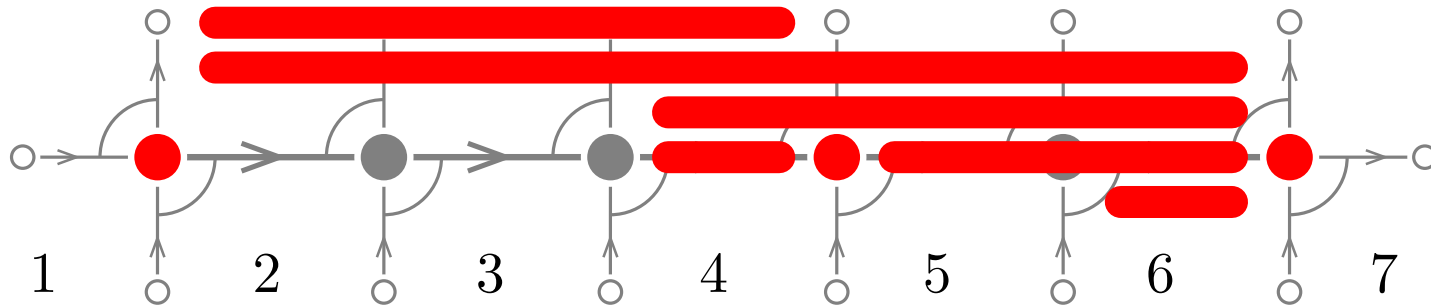

NON-KISSING INSERTION

Surjection from biclosed sets of strings to non-kissing facets

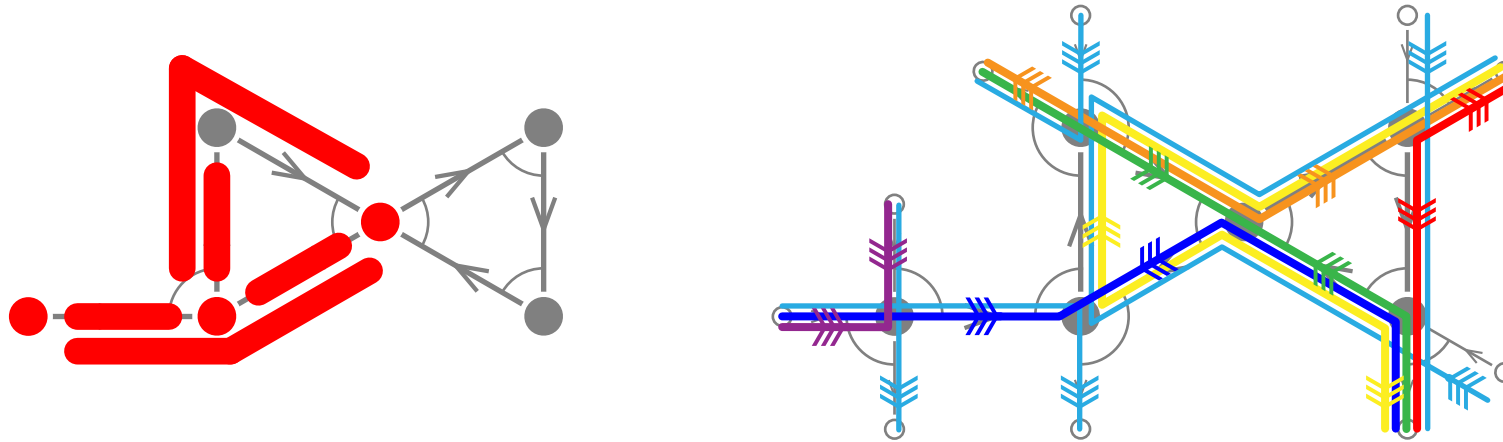

PROP. $\eta(S) := \{\omega(\alpha, S) \mid \alpha \in Q_1\}$ is a non-kissing facet.

THM. The map η defines a lattice morphism from biclosed sets to non-kissing facets.

NON-KISSING LATTICE

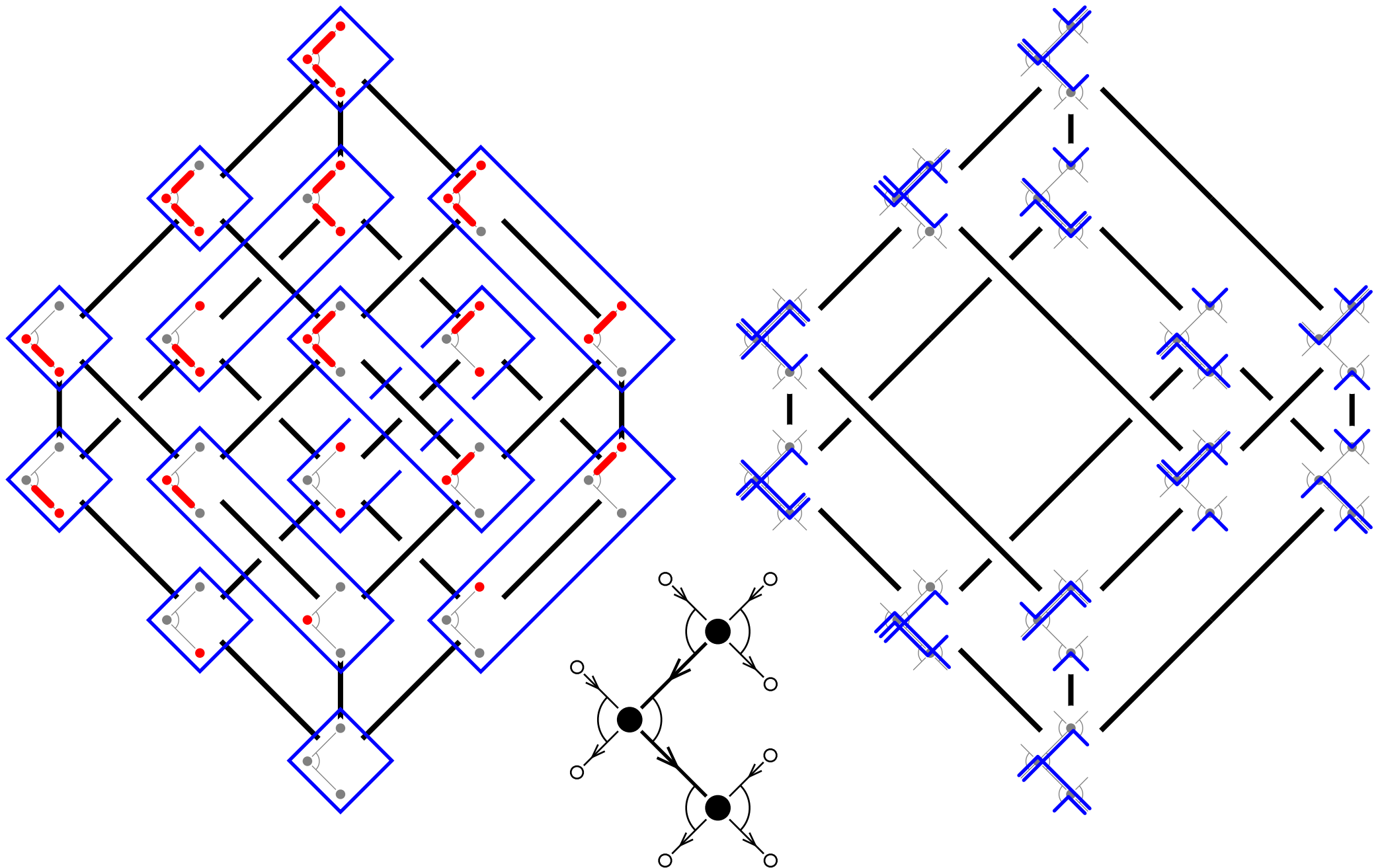

NON-KISSING LATTICE

THM. For a gentle quiver \bar{Q} with finite non-kissing complex $\mathcal{C}_{\text{nk}}(\bar{Q})$, the non-kissing flip graph is the Hasse diagram of a congruence-uniform lattice.

Much more nice combinatorics:

- join-irreducible elements of $\mathcal{L}_{\text{nk}}(\bar{Q})$ are in bijection with distinguishable strings
- canonical join complex of $\mathcal{L}_{\text{nk}}(\bar{Q})$ is a generalization of non-crossing partitions

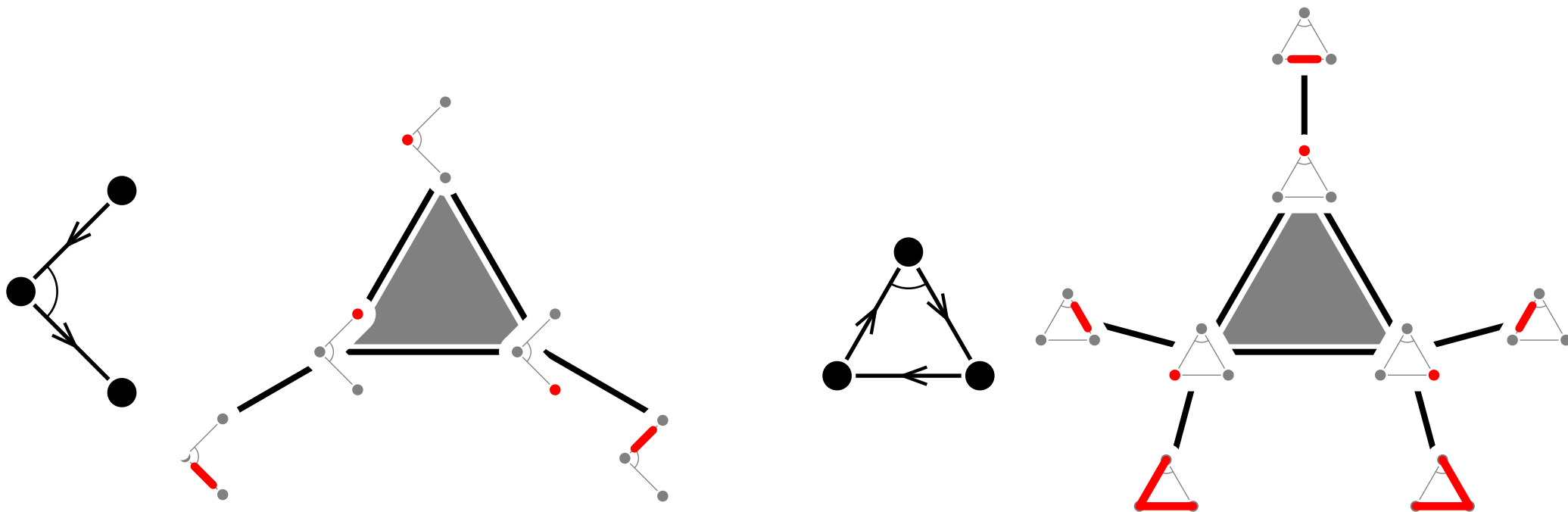

SUMMARY

\bar{Q} gentle quiver

[reduced] non-kissing complex $\mathcal{K}_{\text{nk}}(\bar{Q}) =$ simplicial complex with

- vertices = [bended] walks of \bar{Q}
- faces = collections of pairwise non-kissing [bended] walks of \bar{Q}

THM. For a gentle quiver \bar{Q} with finite $\mathcal{C}_{\text{nk}}(\bar{Q})$, the non-kissing flip graph is

- the 1-skeleton of a polytope,
- the Hasse diagram of a congruence-uniform lattice.

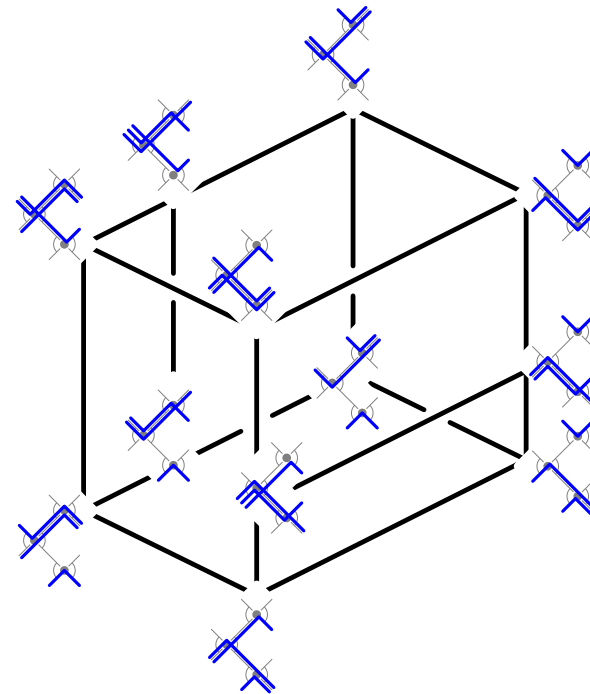
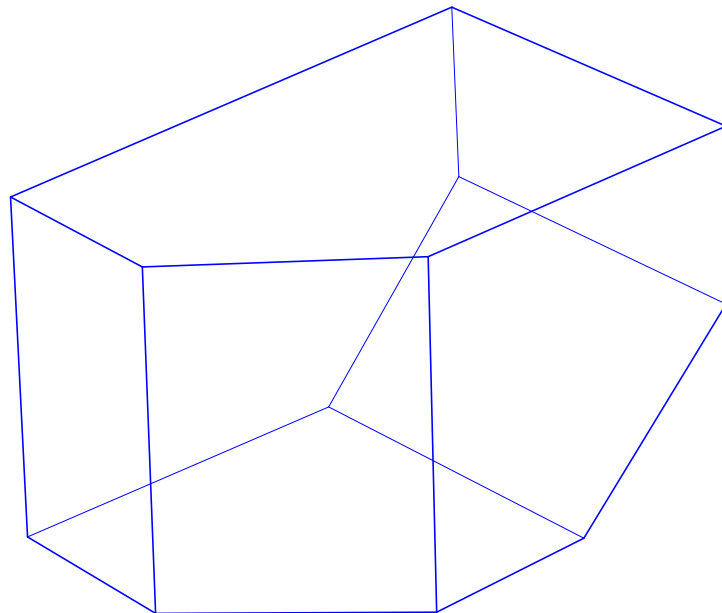
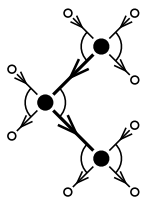

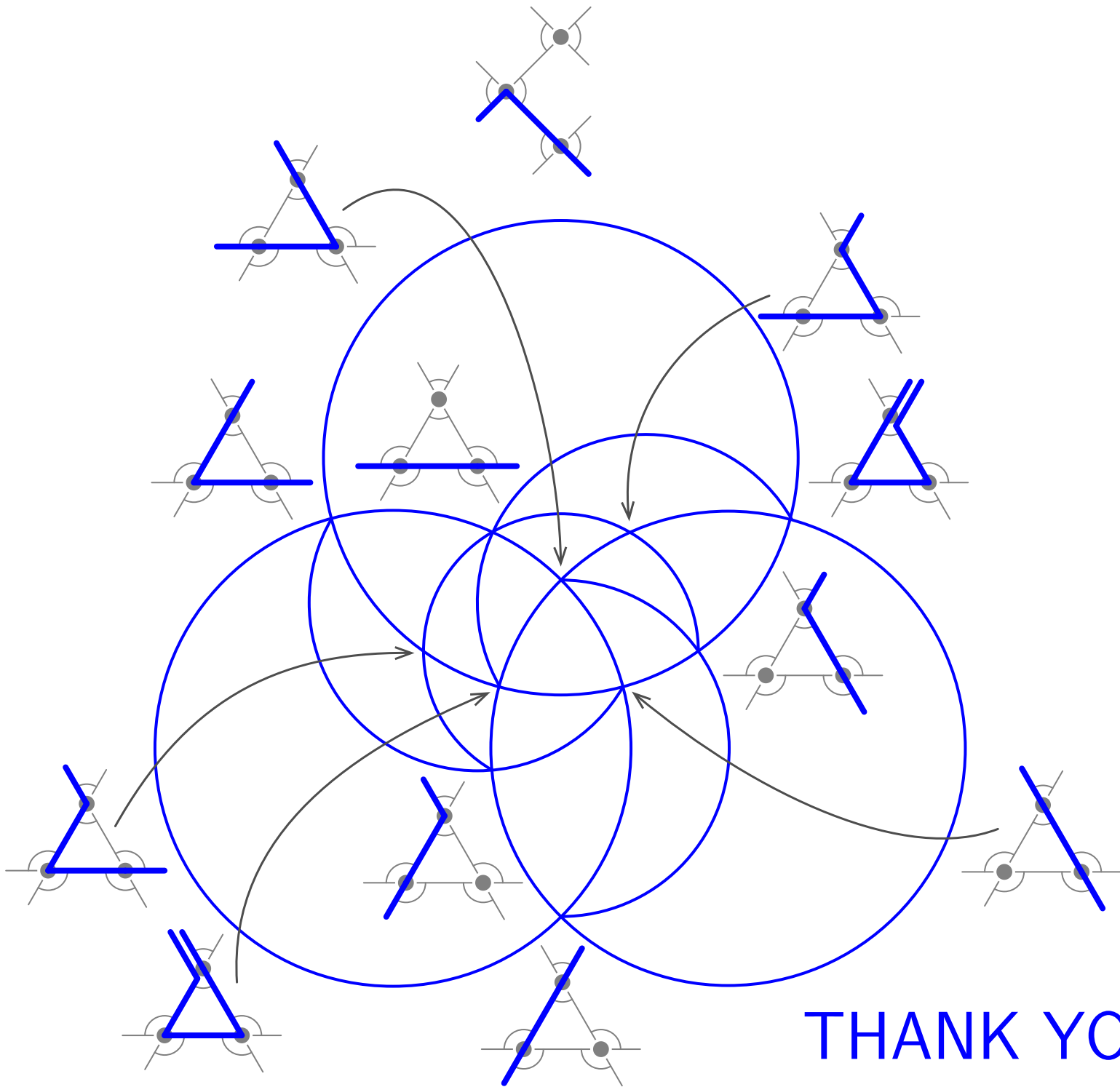

THANK YOU