

# Triangulations

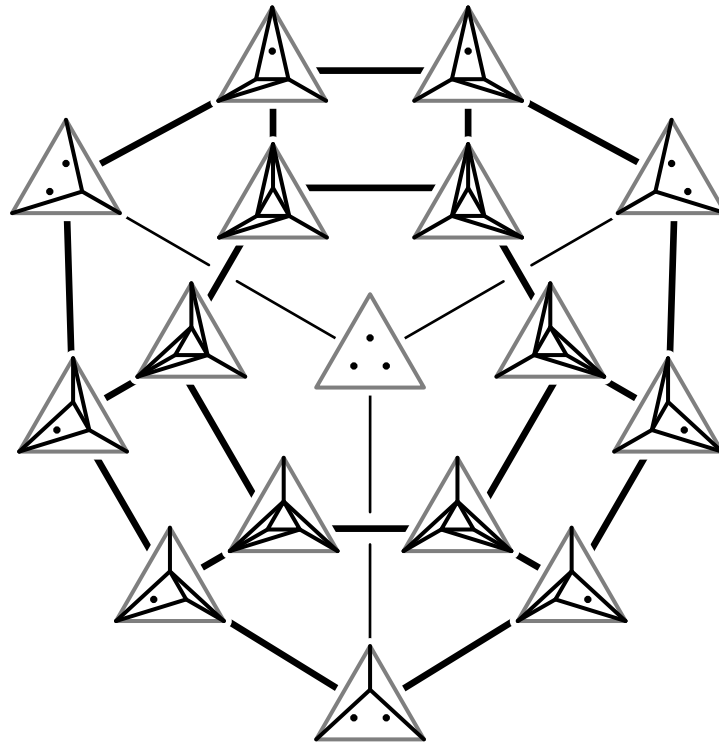

V. PILAUD

MPRI 2-38-1. Algorithms and combinatorics for geometric graphs

Fridays October 7th & October 14th, 2022

slides available at: <http://www.lix.polytechnique.fr/~pilaud/enseignement/MPRI/MPRI-2-38-1-VP-4.pdf>

Course notes available at: <https://www.lix.polytechnique.fr/~pilaud/enseignement/MPRI/notesCoursMPRI21.pdf>

---

# TRIANGULATIONS & SUBDIVISIONS

---

# SUBDIVISIONS

DEF.  $P$  = point set in  $\mathbb{R}^d$ .

polyhedral subdivision of  $P$  = collection  $\mathcal{S}$  of subsets of  $P$  st:

- closure property: if  $\text{conv}(\mathbf{X})$  is a face of  $\text{conv}(\mathbf{Y})$  and  $\mathbf{Y} \in \mathcal{S}$ , then  $\mathbf{X} \in \mathcal{S}$ ,
- union property:  $\text{conv}(P) = \bigcup_{\mathbf{X} \in \mathcal{S}} \text{conv}(\mathbf{X})$ ,
- intersection property:  $\text{conv}(\mathbf{X})$  and  $\text{conv}(\mathbf{Y})$  have disjoint relative interiors and intersect along a face of both, for any  $\mathbf{X}, \mathbf{Y} \in \mathcal{S}$ .

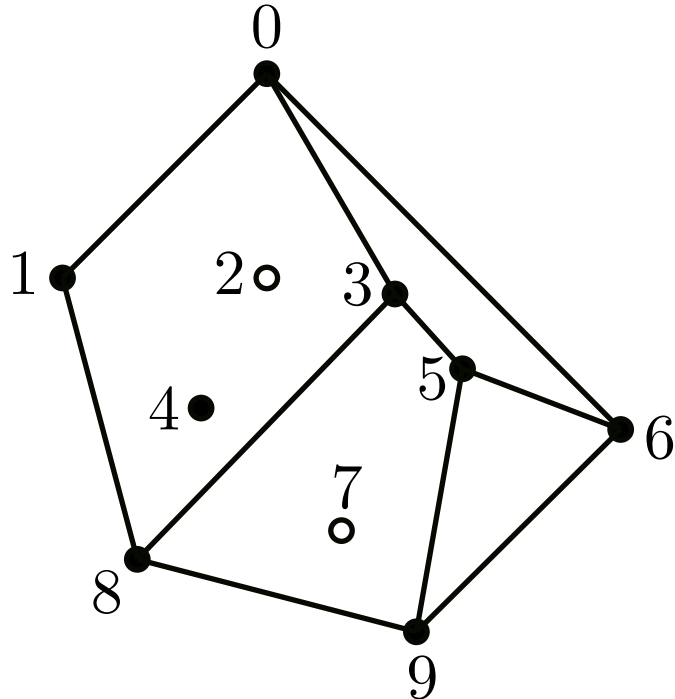

$$\mathcal{S} = \{01348, 0356, 3589, 569\} + \text{all faces...}$$

# TRIANGULATIONS

**DEF.** triangulation = subdivision  $\mathcal{T}$  where all subsets are affinely independent.  
(in particular,  $\text{conv}(\mathbf{X})$  is a simplex for all  $\mathbf{X} \in \mathcal{T}$ ).

full triangulation = each point belongs to at least one simplex.

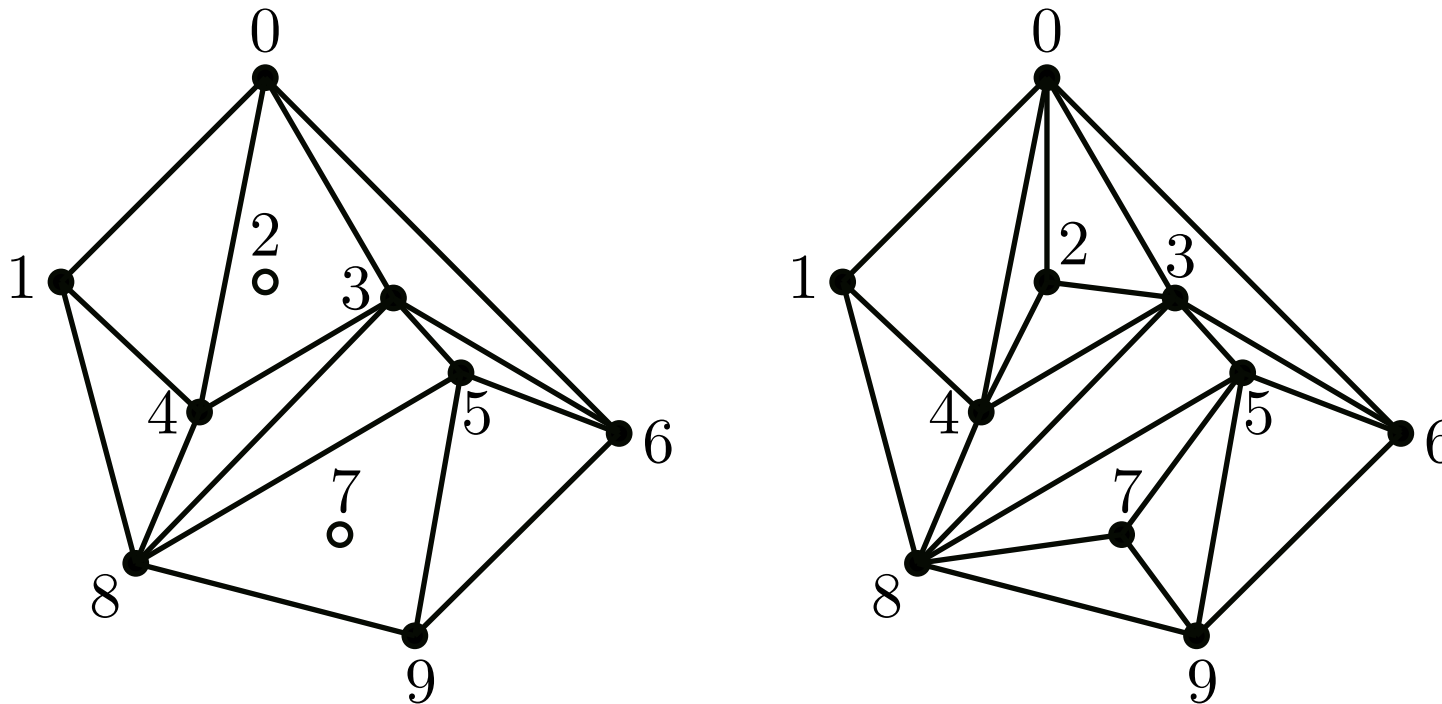

**QU.** Show that any full triangulation of a planar point set with  $i$  interior and  $b$  boundary points has  $i + b$  vertices,  $3i + 2b - 3$  edges, and  $2i + b - 2$  triangles.

## TRIANGULATIONS IN 3 DIMENSION

---

QU. What is the minimum / maximum number of simplices that triangulate the 3-cube?

# TRIANGULATIONS IN 3 DIMENSION

QU. What is the minimum / maximum number of simplices that triangulate the 3-cube?

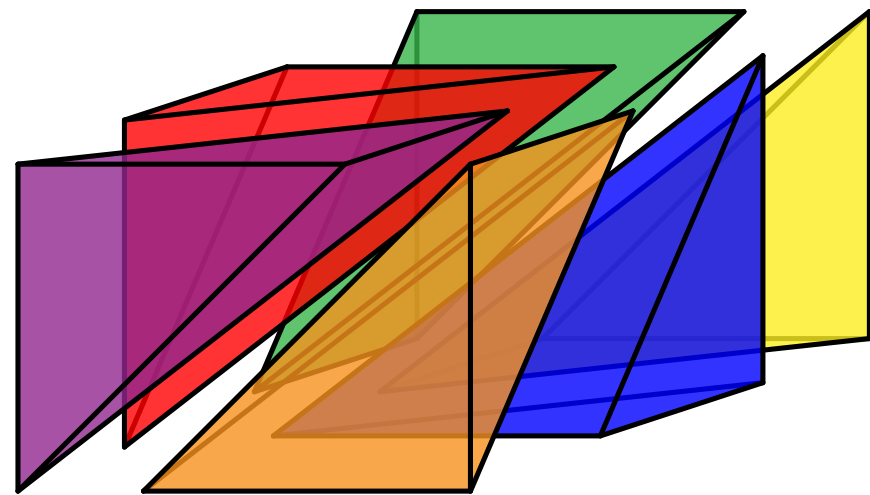
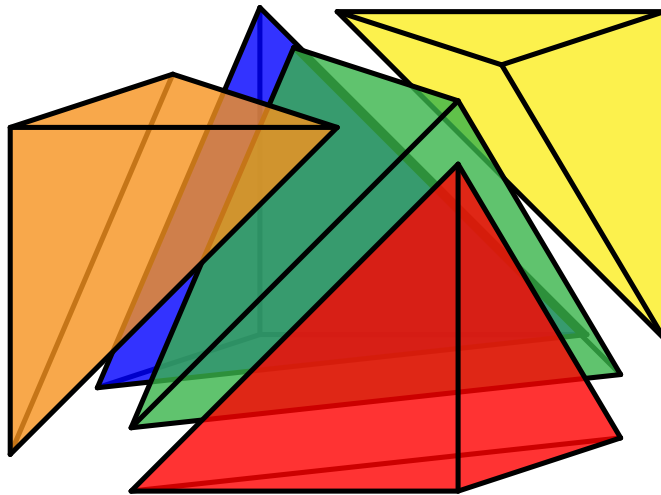
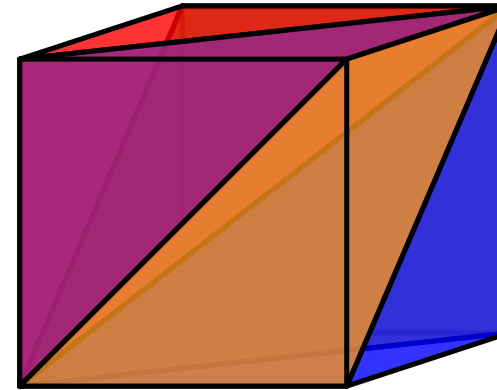
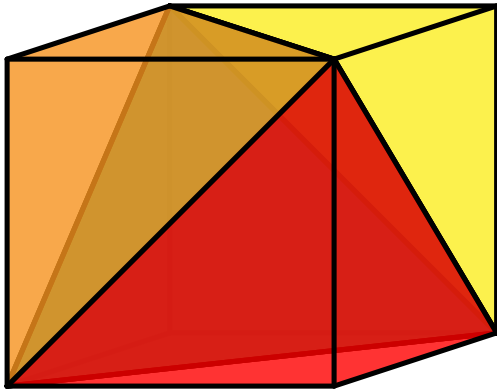

minimum = 5

maximum = 6

In dimension  $d$ , minimum is very difficult, maximum is  $d!$

# FREUDENTHAL TRIANGULATION

**DEF.** Freudenthal triangulation of the  $d$ -cube  $\square_d =$  triangulation with a simplex

$$\Delta_\sigma = \left\{ \sum_{i \leq j} e_{\sigma(i)} \mid 0 \leq j \leq d \right\} = \left\{ \mathbf{x} \in \square_d \mid x_{\sigma(1)} \geq x_{\sigma(2)} \geq \cdots \geq x_{\sigma(d)} \right\}$$

for each permutation  $\sigma \in \mathfrak{S}_d$ .

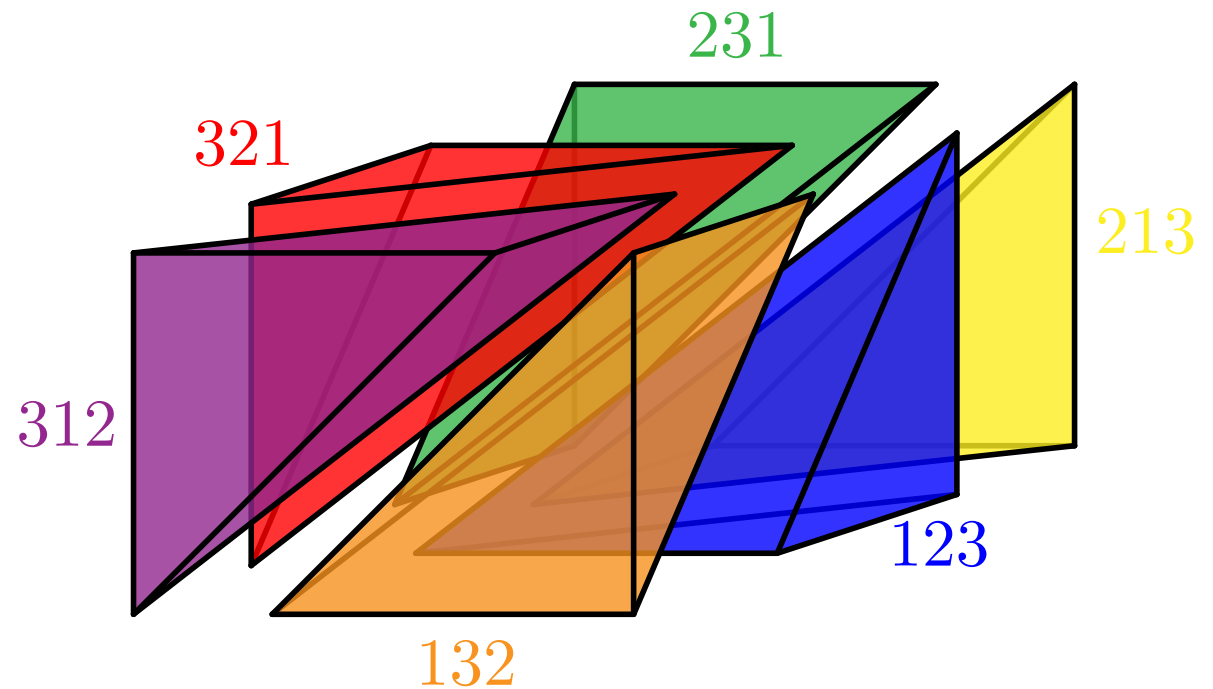
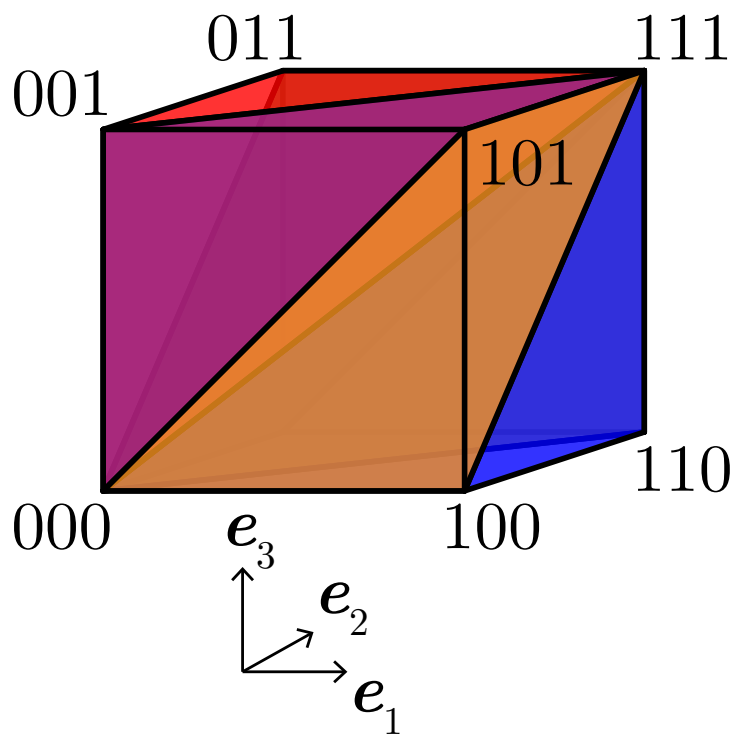

---

# NUMBER OF TRIANGULATIONS

---



# CONVEX POSITION & CATALAN NUMBERS

**PROP.** number triangulations convex  $n$ -gon = Catalan number  $C_{n-2} = \frac{1}{n-1} \binom{2n-4}{n-2}$

$n$	1	2	3	4	5	6	7	8	9	10	11	12	13	14
$C_n$	1	2	5	14	42	132	429	1430	4862	16796	58786	208012	742900	2674440

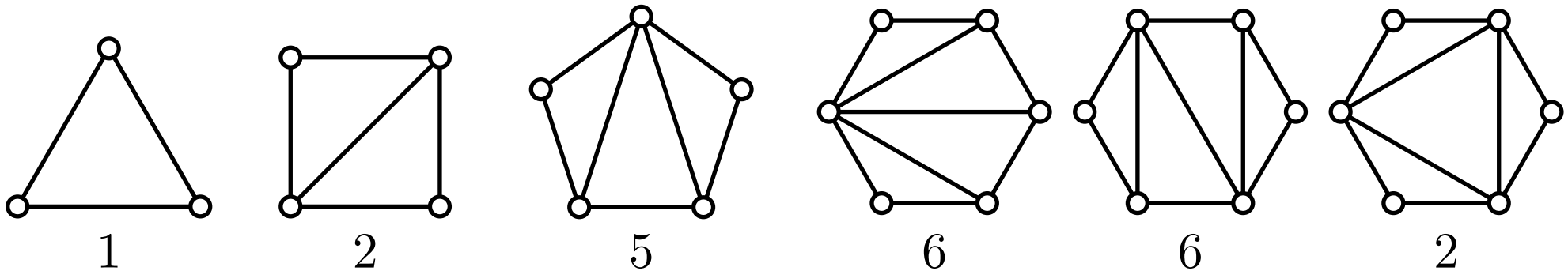

# CONVEX POSITION & CATALAN NUMBERS

**PROP.** number triangulations convex  $n$ -gon = Catalan number  $C_{n-2} = \frac{1}{n-1} \binom{2n-4}{n-2}$

$n$	1	2	3	4	5	6	7	8	9	10	11	12	13	14
$C_n$	1	2	5	14	42	132	429	1430	4862	16796	58786	208012	742900	2674440

proof A: in the triangulations of the  $(n-1)$ -gon:

- number of edges =  $2n - 5$
- average degree of a vertex =  $2(2n - 5)/(n - 1)$

Thus, contracting the triangle containing 1 and  $n$ , we get the induction formula

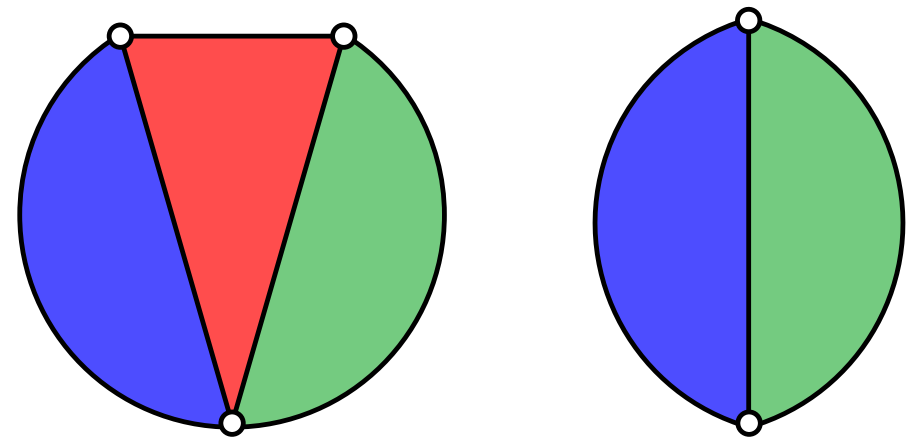

$$T_n = \frac{2(2n-5)}{n-1} T_{n-1} \quad \text{thus} \quad T_n = \frac{2^{n-3}(2n-5)(2n-7)\dots 3}{(n-1)(n-2)\dots 2} T_3 = \frac{1}{n-1} \binom{2n-4}{n-2}.$$

# CONVEX POSITION & CATALAN NUMBERS

**PROP.** number triangulations convex  $n$ -gon = Catalan number  $C_{n-2} = \frac{1}{n-1} \binom{2n-4}{n-2}$

$n$	1	2	3	4	5	6	7	8	9	10	11	12	13	14
$C_n$	1	2	5	14	42	132	429	1430	4862	16796	58786	208012	742900	2674440

proof B: decomposing the triangulation by the triangle containing 1 and  $n$ , we have the summation formula

$$T_n = \sum_{2 \leq j \leq n-1} T_j \cdot T_{n-j+1}$$

For the generating function  $T(x) = \sum_{j \geq 2} T_j x^{j-2}$ , this gives

$$T(x) = 1 + x \cdot T(x)^2 \quad \text{thus} \quad T(x) = \frac{1 + \sqrt{1 - 4x}}{2x}.$$

We then get  $T_j$  developing the series.

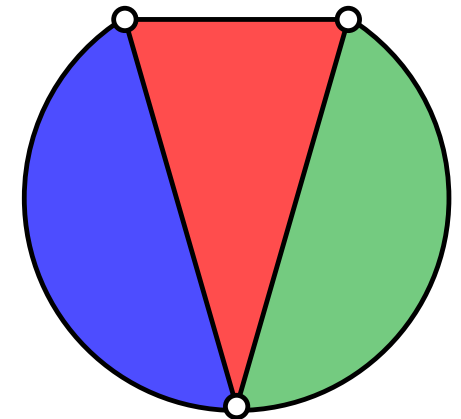

# CATALAND

- QU. Show that the following are Catalan families (ie. counted by Catalan numbers):
- (i) triangulations of a convex  $n$ -gon,
  - (ii) binary trees with  $n - 2$  internal nodes,
  - (iii) rooted plane trees with  $n - 1$  nodes,
  - (iv) Dyck paths of length  $2n - 4$  (ie. paths with up steps  $\nearrow$  and down steps  $\searrow$  starting at  $(0, 0)$  finishing at  $(2n - 4, 0)$  and which never go below the horizontal axis),
  - (v) valid bracketings of a non-associative product on  $n - 1$  elements.

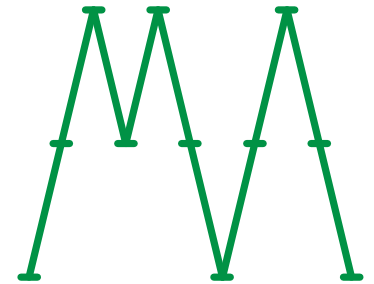
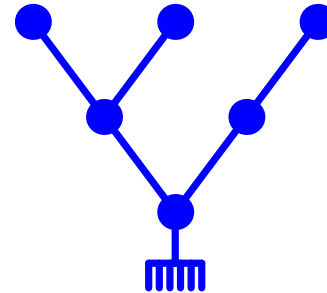
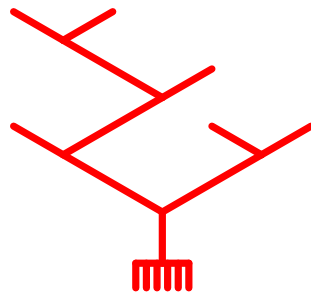
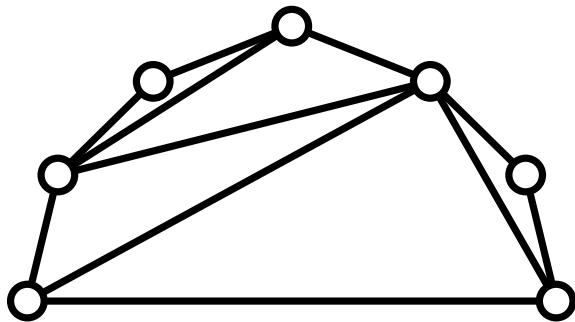

# CATALAND

**PRO.** The following are Catalan families (ie. counted by Catalan numbers):

- (i) triangulations of a convex  $n$ -gon,
- (ii) binary trees with  $n - 2$  internal nodes,
- (iii) rooted plane trees with  $n - 1$  nodes,
- (iv) Dyck paths of length  $2n - 4$  (ie. paths with up steps  $\nearrow$  and down steps  $\searrow$  starting at  $(0, 0)$  finishing at  $(2n - 4, 0)$  and which never go below the horizontal axis),
- (v) valid bracketings of a non-associative product on  $n - 1$  elements.

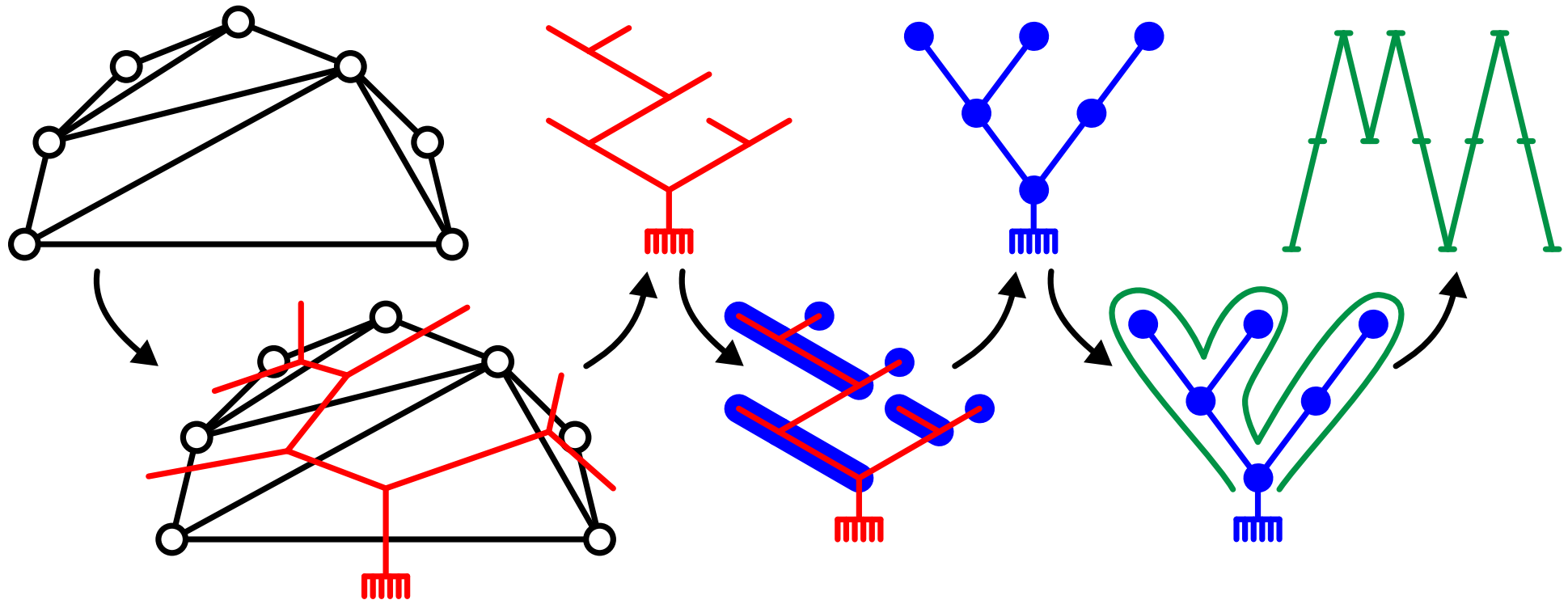

## DOUBLE CHAIN AND DOUBLE CIRCLE

---

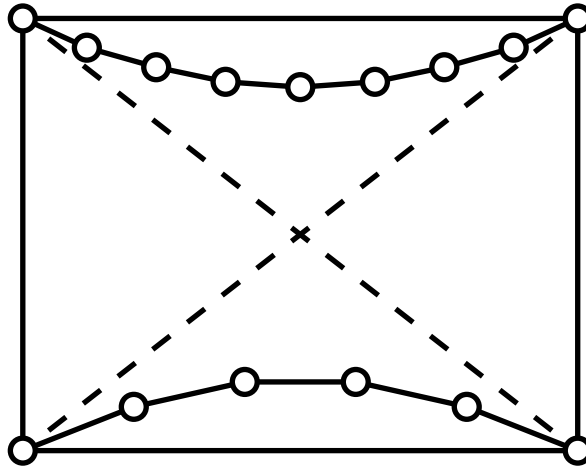

double chain

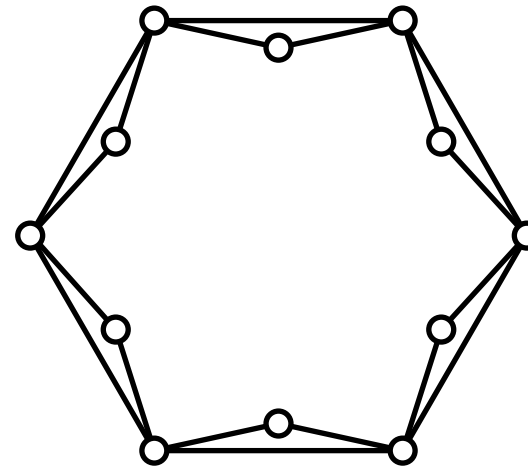

double circle

QU. Compute the numbers of full triangulations of the double chain and double circle.

## DOUBLE CHAIN AND DOUBLE CIRCLE

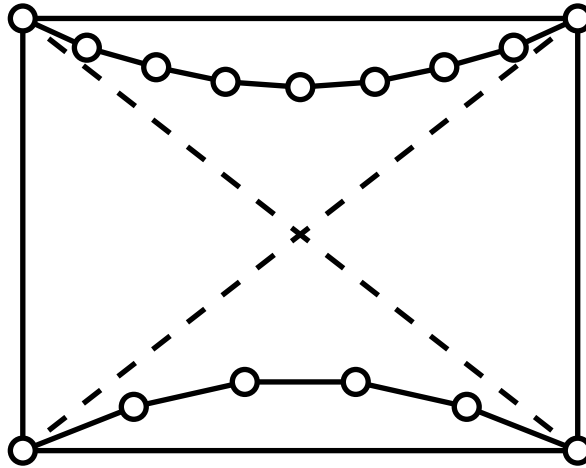

double chain

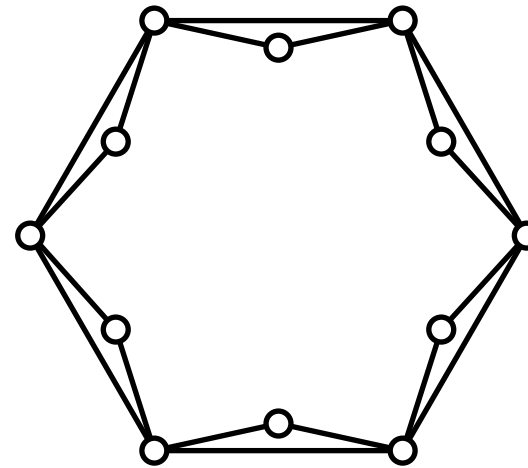

double circle

**PROP.** The numbers of full triangulations of the double chain and double circle are

$$C_m C_n \binom{m+n+2}{m+1} \quad \text{and} \quad \sum_{i \in [n]} (-1)^i \binom{n}{i} C_{n+i-2}.$$

proof:

- db chain: all edges of the chains belong to full triangulations...
- db circle: inclusion-exclusion for triangulations of convex polygon with no even ear.

**QU.** What about all triangulations?

# UPPER AND LOWER BOUNDS

**THM.** Any planar point set in general position with  $i$  interior and  $b$  boundary points has at least  $C_{b-2} 2^{i-b+2} = \Omega(2^n n^{-3/2})$  and at most  $59^i 7^b / \binom{i+b+6}{6} \leq 59^n$  full triangulations.

proof: For the lower bound:

1. if  $b = 3$ :

- check it for  $i \leq 8$ . This is a combinatorial problem!
- use stacked triangulations:

each point separates the triangle into three regions

with  $i = i_1 + i_2 + i_3 + 1$ , thus defines at least

$2^{i_1-1} \cdot 2^{i_2-1} \cdot 2^{i_3-1} = 2^{i-4}$  stacked triangulations

thus in total, at least  $i 2^{i-4} \geq 2^{i-1}$  stacked triangulations.

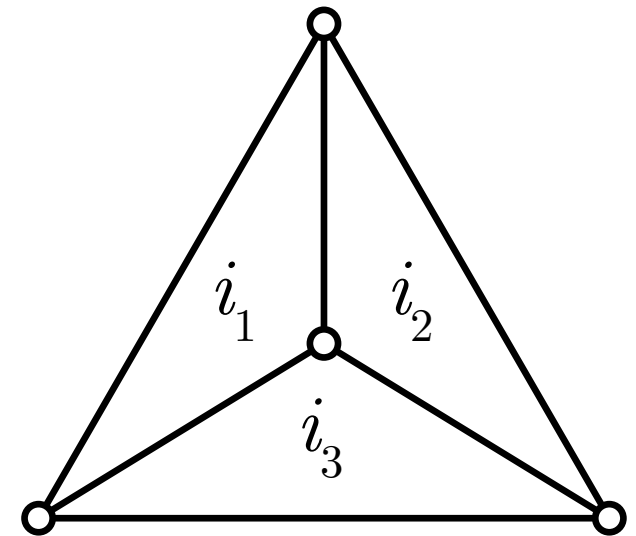

2. if  $b \geq 4$ , choose a triangulation of the boundary, and stack in all triangles.

For the upper bound: see poly...



---

FLIPS

---

# FLIPS

DEF. flip = local operation on triangulations of  $P$  defined as:

- diagonal flip = if  $pqr$  and  $prs$  form a convex quadrilateral  $pqrs$ , replace the diagonal  $pr$  by the other diagonal  $qs$  of  $pqrs$ .

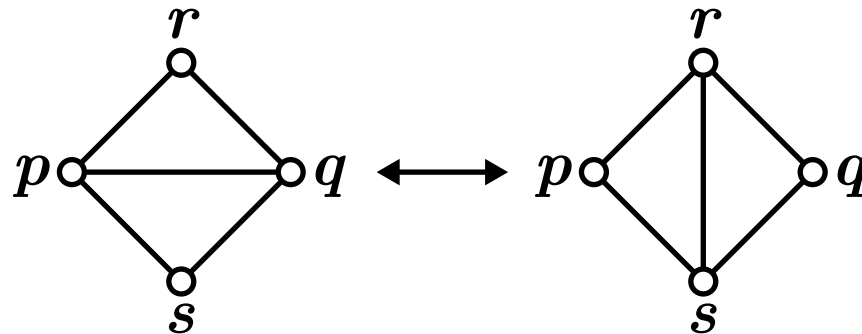

- insertion/deletion flip = if a point  $p$  is contained in the interior of a triangle  $uvw$ , then insert the edges  $pu$ ,  $pv$ , and  $pw$  or vice-versa.

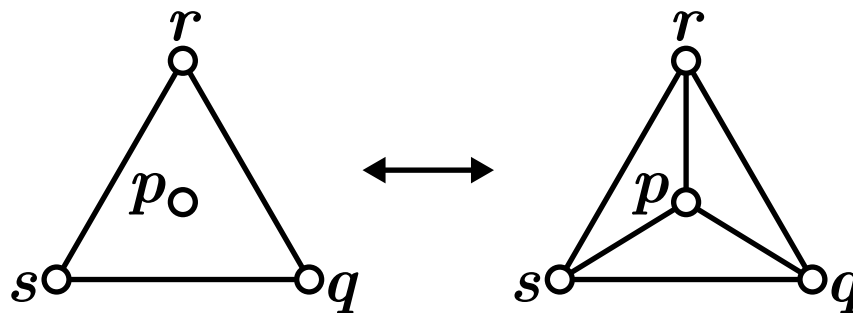

DEF. flip graph = graph with vertices = triangulations and edges = flips.

# FLIP GRAPH

---

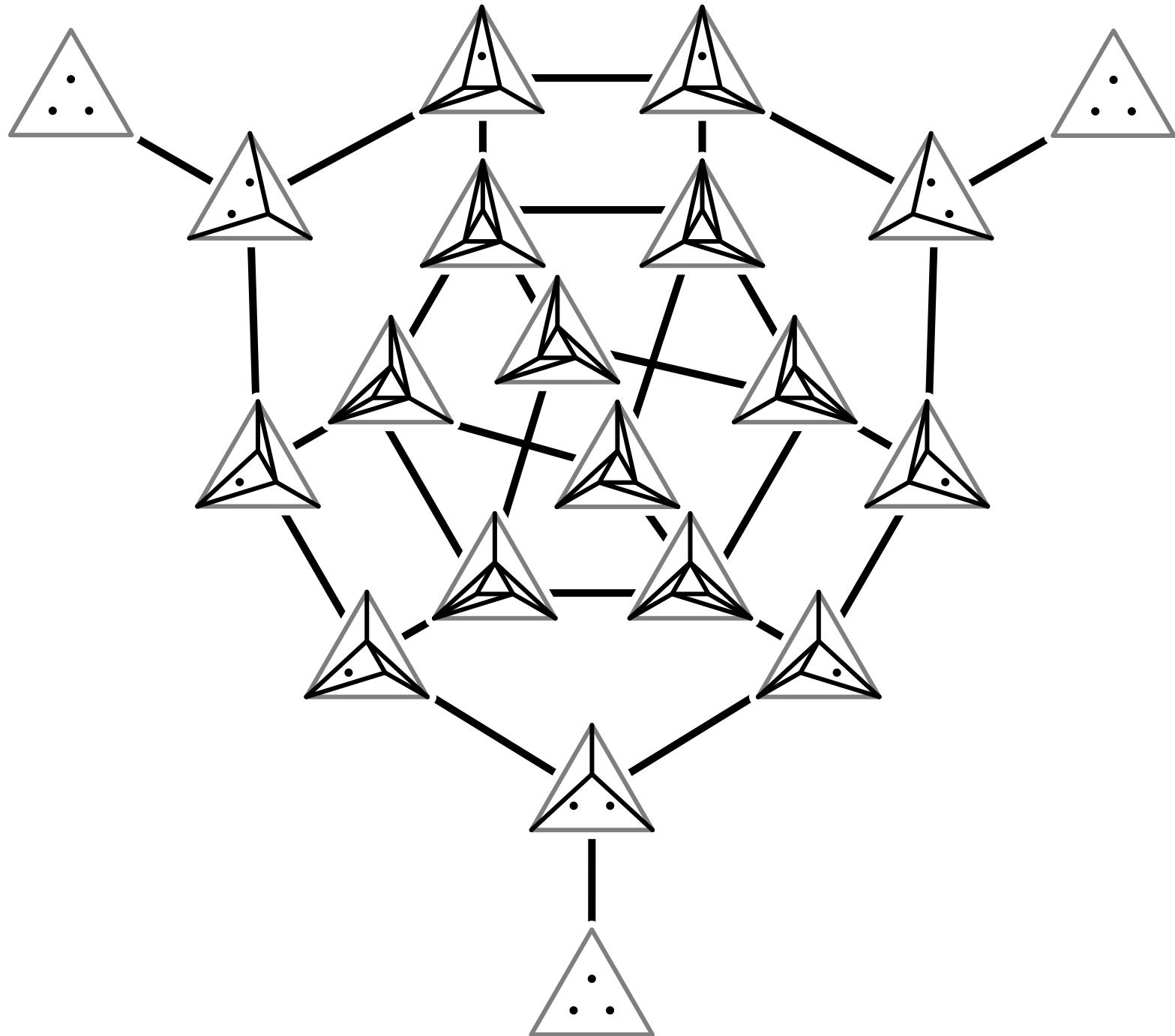

# FLIPS IN HIGHER DIMENSION

**THM.** For any set  $\mathbf{X}$  of  $d+2$  points in  $\mathbb{R}^d$ , there exists a partition  $\mathbf{X} = \mathbf{X}^+ \sqcup \mathbf{X}^- \sqcup \mathbf{X}^\circ$  such that  $\text{conv}(\mathbf{X}^+) \cap \text{conv}(\mathbf{X}^-) \neq \emptyset$ .

proof: There is an affine dependence  $\sum_{x \in \mathbf{X}} \lambda_x \mathbf{x} = 0$  with  $\sum_{x \in \mathbf{X}} \lambda_x = 0$  (to see it, linearize).

Let  $\mathbf{X}^+ = \{x \in \mathbf{X} \mid \lambda_x > 0\}$     $\mathbf{X}^- = \{x \in \mathbf{X} \mid \lambda_x < 0\}$     $\mathbf{X}^\circ = \{x \in \mathbf{X} \mid \lambda_x = 0\}$ .

Then  $\Lambda = \sum_{x^+ \in \mathbf{X}^+} \lambda_{x^+} = \sum_{x^- \in \mathbf{X}^-} (-\lambda_{x^-})$  and  $\frac{1}{\Lambda} \sum_{x^+ \in \mathbf{X}^+} \lambda_{x^+} \mathbf{x}^+ = \frac{1}{\Lambda} \sum_{x^- \in \mathbf{X}^-} (-\lambda_{x^-}) \mathbf{x}^-$ .

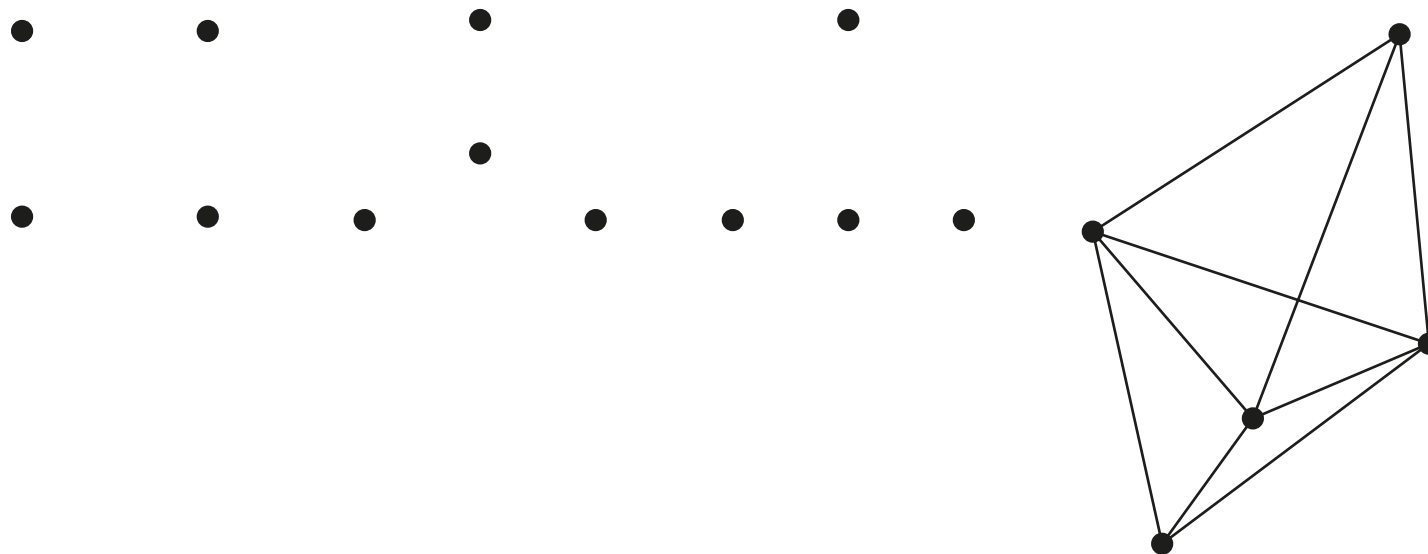

# FLIPS IN HIGHER DIMENSION

**THM.** For any set  $\mathbf{X}$  of  $d+2$  points in  $\mathbb{R}^d$ , there exists a partition  $\mathbf{X} = \mathbf{X}^+ \sqcup \mathbf{X}^- \sqcup \mathbf{X}^\circ$  such that  $\text{conv}(\mathbf{X}^+) \cap \text{conv}(\mathbf{X}^-) \neq \emptyset$ .

proof: There is an affine dependence  $\sum_{x \in \mathbf{X}} \lambda_x \mathbf{x} = 0$  with  $\sum_{x \in \mathbf{X}} \lambda_x = 0$  (to see it, linearize).

Let  $\mathbf{X}^+ = \{x \in \mathbf{X} \mid \lambda_x > 0\}$      $\mathbf{X}^- = \{x \in \mathbf{X} \mid \lambda_x < 0\}$      $\mathbf{X}^\circ = \{x \in \mathbf{X} \mid \lambda_x = 0\}$ .

Then  $\Lambda = \sum_{x^+ \in \mathbf{X}^+} \lambda_{x^+} = \sum_{x^- \in \mathbf{X}^-} (-\lambda_{x^-})$  and  $\frac{1}{\Lambda} \sum_{x^+ \in \mathbf{X}^+} \lambda_{x^+} \mathbf{x}^+ = \frac{1}{\Lambda} \sum_{x^- \in \mathbf{X}^-} (-\lambda_{x^-}) \mathbf{x}^-$ .

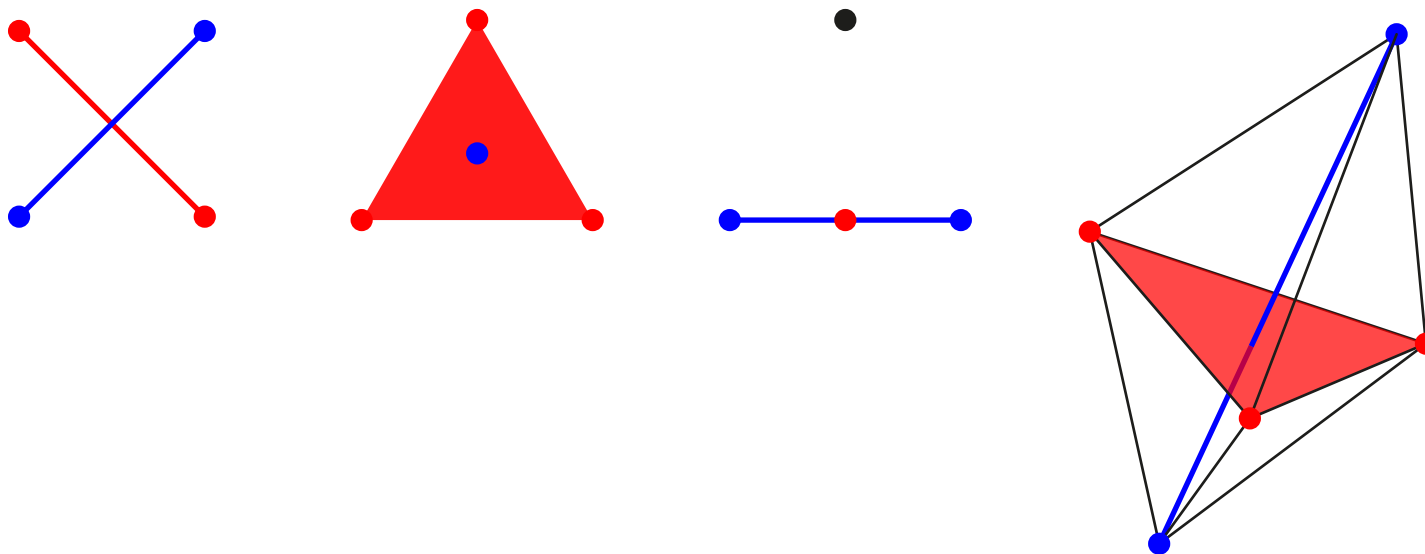

# FLIPS IN HIGHER DIMENSION

**THM.** For any set  $X$  of  $d+2$  points in  $\mathbb{R}^d$ , there exists a partition  $X = X^+ \sqcup X^- \sqcup X^\circ$  such that  $\text{conv}(X^+) \cap \text{conv}(X^-) \neq \emptyset$ .

**DEF.**  $X$  set of  $d+2$  points in  $\mathbb{R}^d$ .

$X = X^+ \sqcup X^- \sqcup X^\circ$  Radon partition of  $X$  with (inclusion) maximal  $X^\circ$ .

Bistellar flip =  $\{ \text{conv}(X \setminus \{x\}) \mid x \in X^+ \} \longleftrightarrow \{ \text{conv}(X \setminus \{x\}) \mid x \in X^- \}$

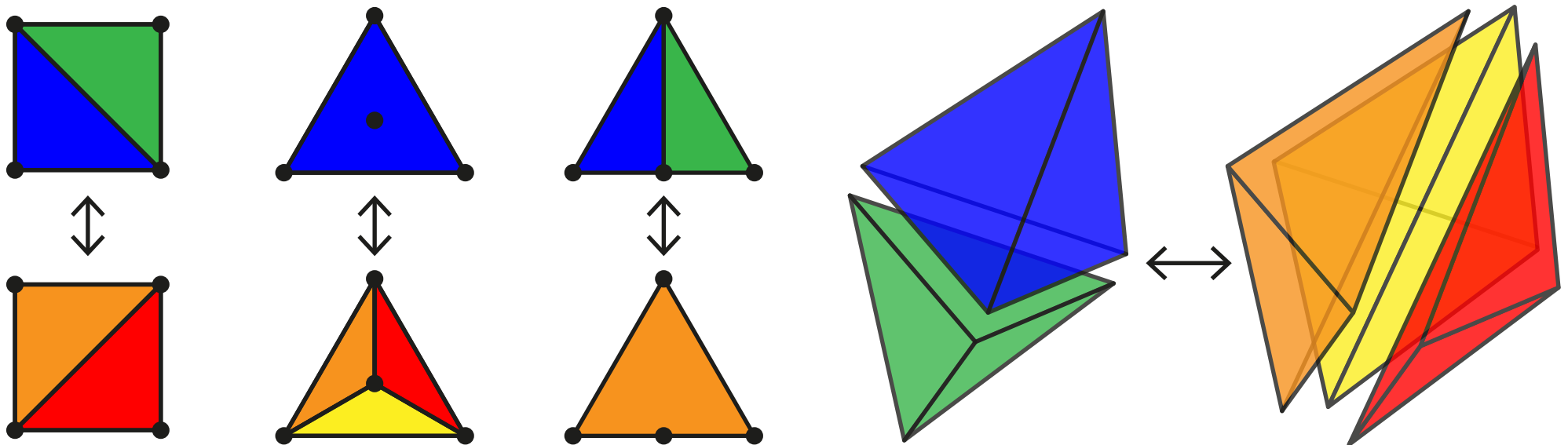

# FLIPS IN HIGHER DIMENSION

QU. How many flips to connect these triangulations of the 3-cube?

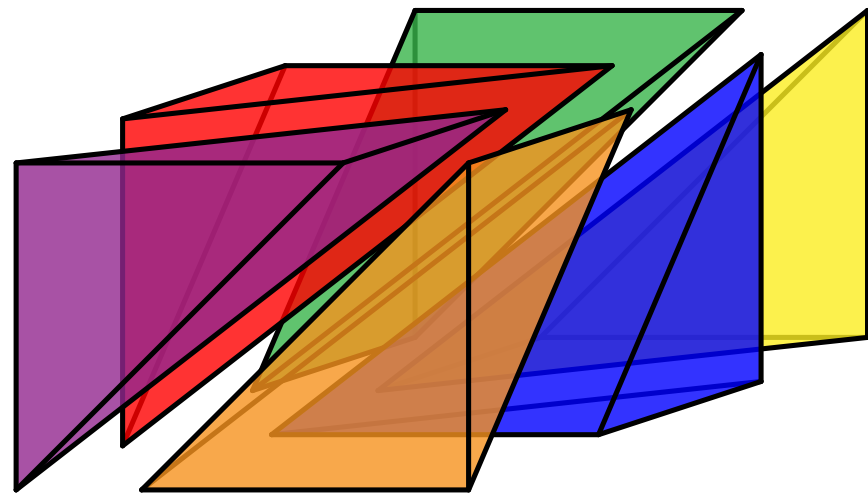
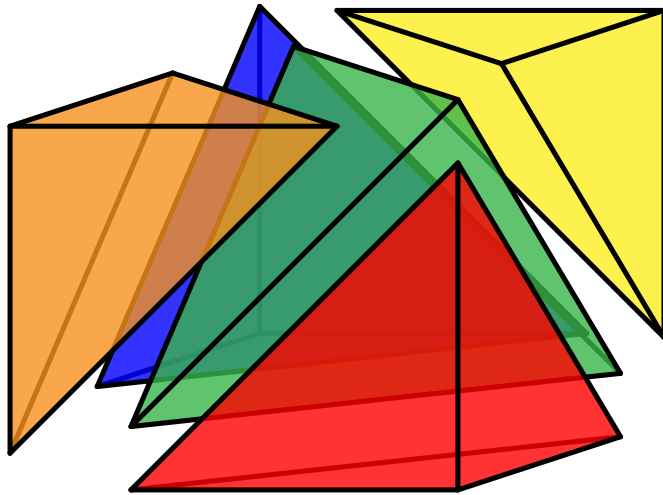
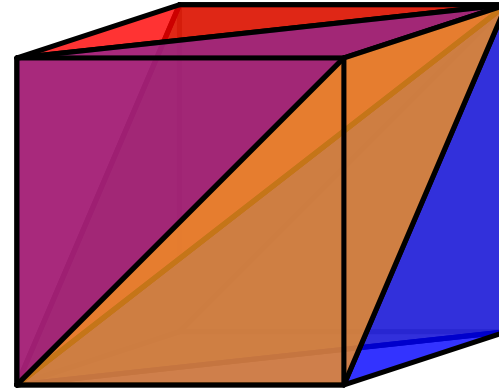
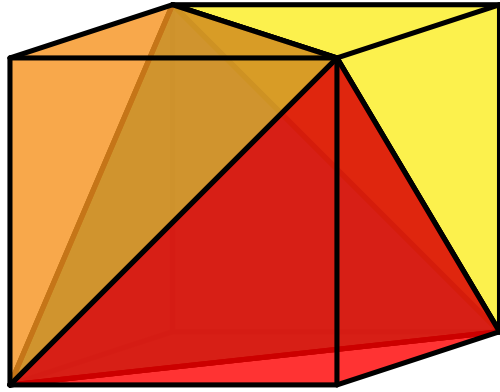

# FLIPS IN HIGHER DIMENSION

QU. How many flips to connect these triangulations of the 3-cube?

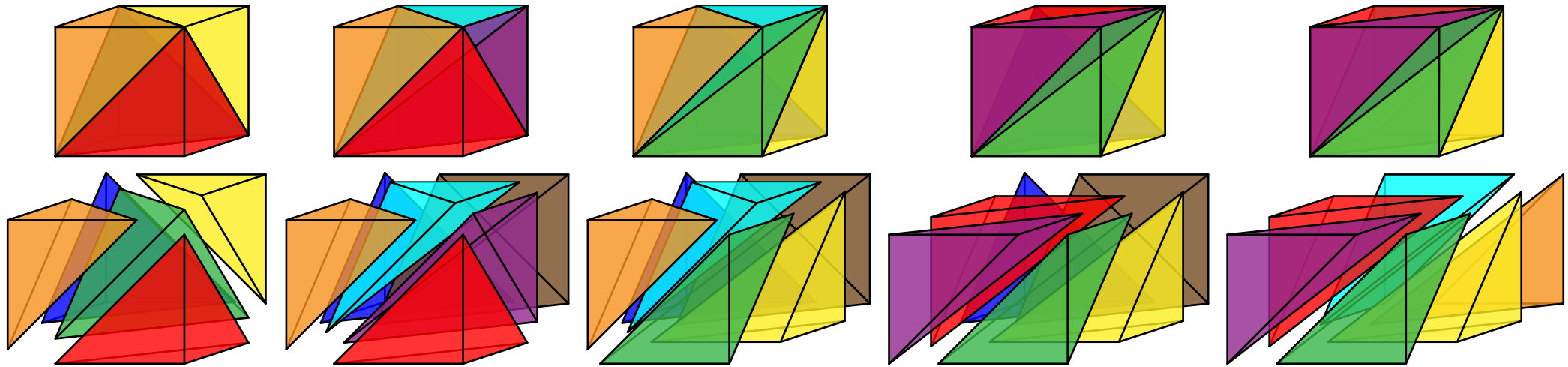



---

# DELAUNAY TRIANGULATION (AGAIN)

---

# VORONOI DIAGRAM

DEF.  $P$  = set of sites in  $\mathbb{R}^n$ .

Voronoi region  $\text{Vor}(p, P) = \{x \in \mathbb{R}^2 \mid \|x - p\| \leq \|x - q\| \text{ for all } q \in P\}$ .

Voronoi diagram  $\text{Vor}(P) = \text{partition of } \mathbb{R}^n \text{ formed by } \text{Vor}(p, P) \text{ for } p \in P$ .

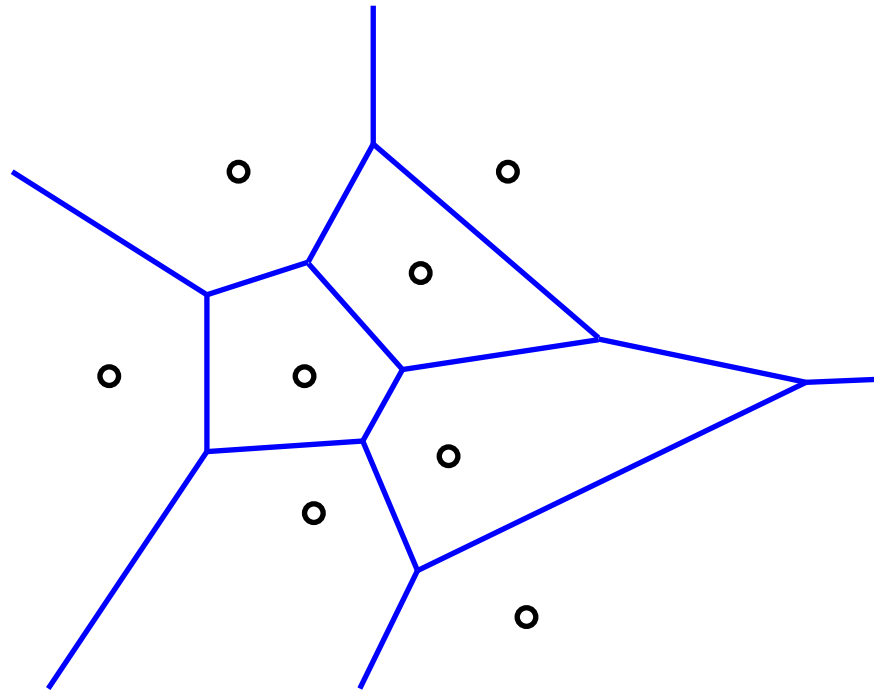

# VORONOI DIAGRAM

DEF.  $P$  = set of sites in  $\mathbb{R}^n$ .

Voronoi region  $\text{Vor}(\mathbf{p}, P) = \{ \mathbf{x} \in \mathbb{R}^2 \mid \|\mathbf{x} - \mathbf{p}\| \leq \|\mathbf{x} - \mathbf{q}\| \text{ for all } \mathbf{q} \in P \}$ .

Voronoi diagram  $\text{Vor}(P) = \text{partition of } \mathbb{R}^n \text{ formed by } \text{Vor}(\mathbf{p}, P) \text{ for } \mathbf{p} \in P$ .

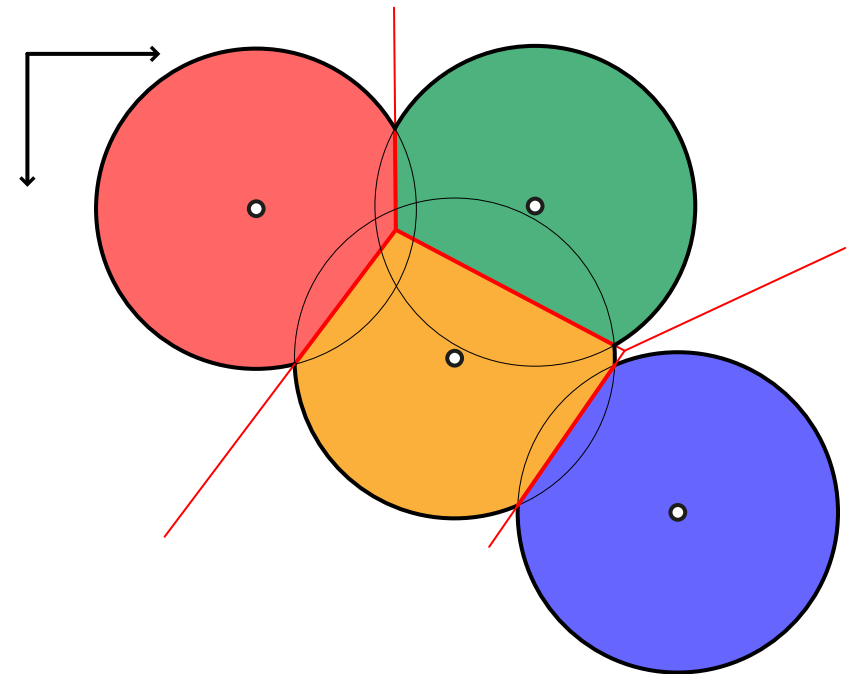
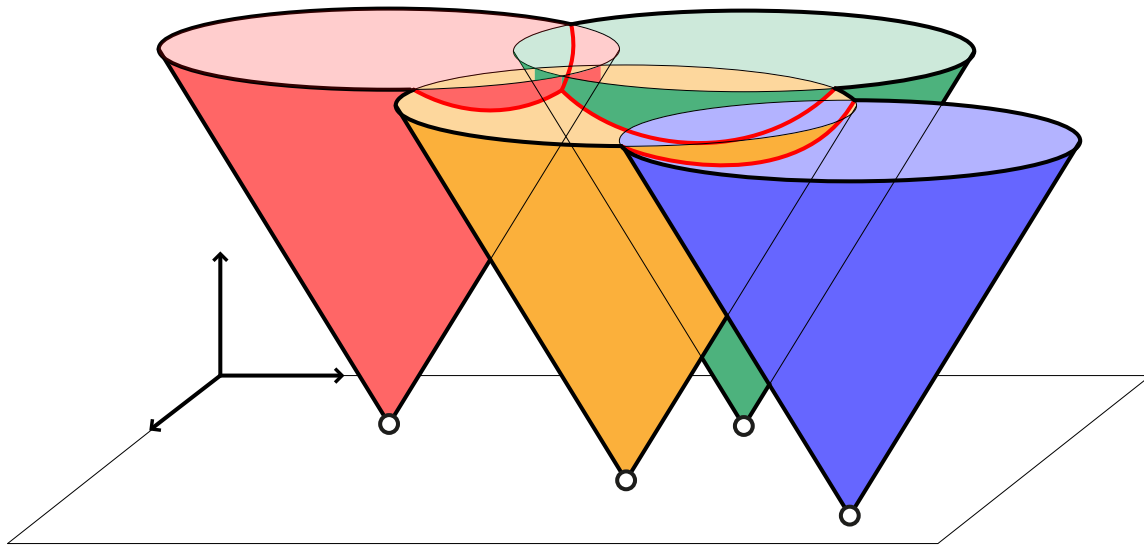

# LIFTING POINTS ON THE PARABOLOID

---

paraboloid  $\mathcal{P}$  with equation  $x_{d+1} = \sum_{i \in [d]} x_i^2$ .

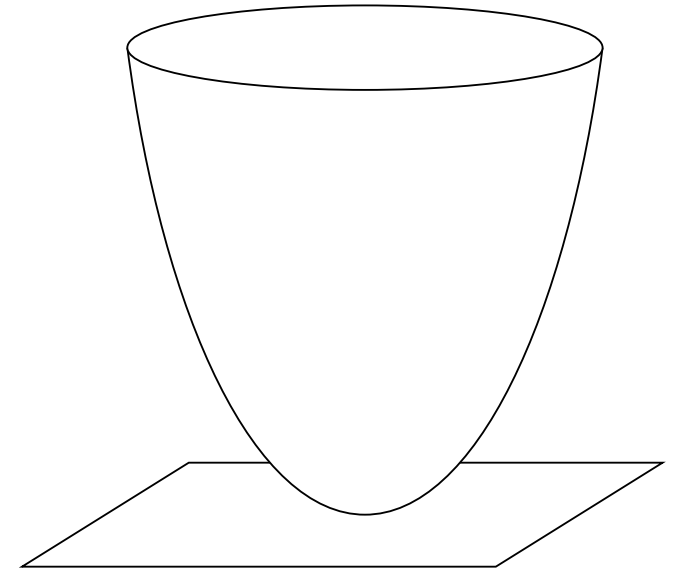

# LIFTING POINTS ON THE PARABOLOID

---

paraboloid  $\mathcal{P}$  with equation  $x_{d+1} = \sum_{i \in [d]} x_i^2$ .

lifting function  $\mathbf{p} \in \mathbb{R}^d \mapsto \hat{\mathbf{p}} = (\mathbf{p}, \|\mathbf{p}\|^2) \in \mathbb{R}^{d+1}$ .

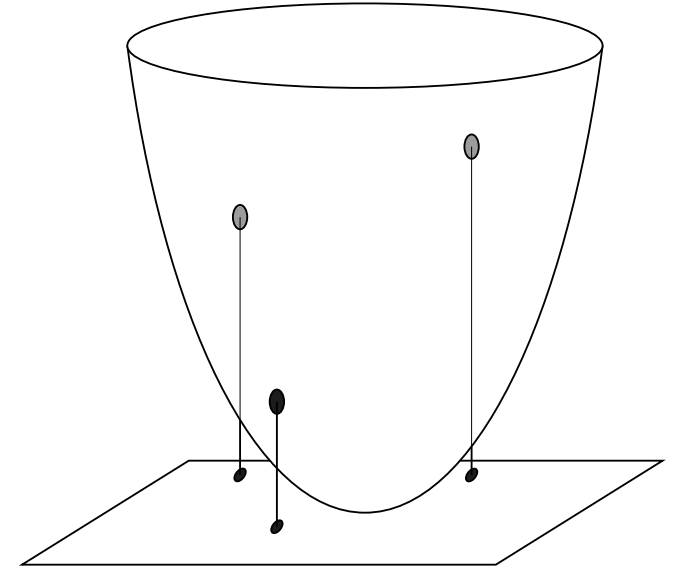

# LIFTING POINTS ON THE PARABOLOID

paraboloid  $\mathcal{P}$  with equation  $x_{d+1} = \sum_{i \in [d]} x_i^2$ .

lifting function  $\mathbf{p} \in \mathbb{R}^d \mapsto \hat{\mathbf{p}} = (\mathbf{p}, \|\mathbf{p}\|^2) \in \mathbb{R}^{d+1}$ .

**PROP.** The Voronoi diagram  $\text{Vor}(\mathbf{P})$  is the vertical projection of the upper envelope of the planes tangent to the paraboloid  $\mathcal{P}$  at the lifted points  $\hat{\mathbf{p}}$  for  $\mathbf{p} \in \mathbf{P}$ .

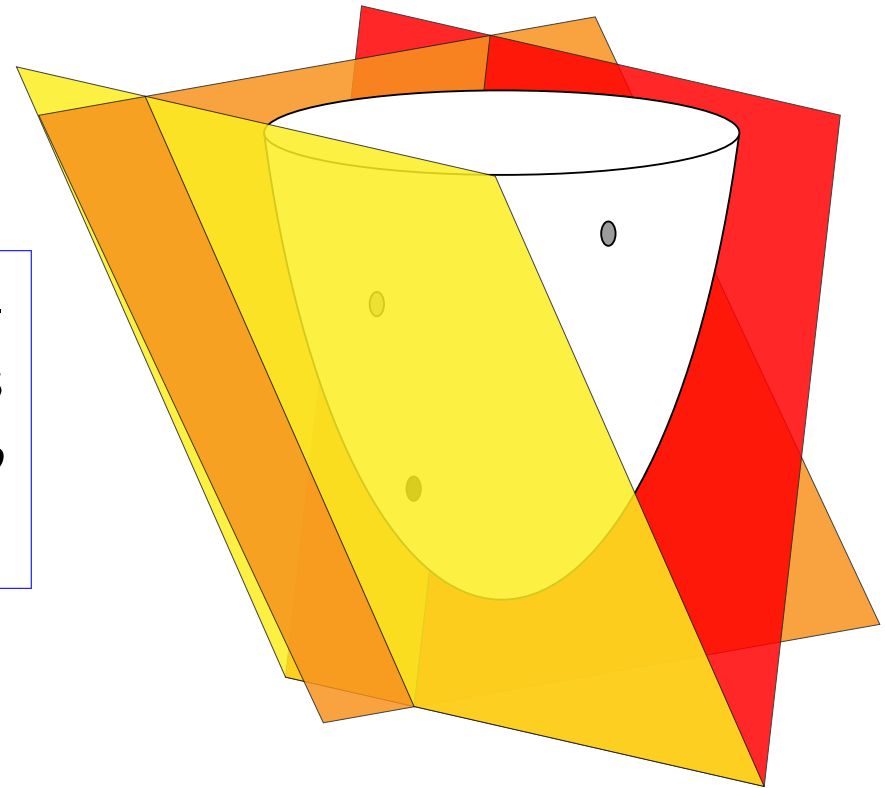

# LIFTING POINTS ON THE PARABOLOID

paraboloid  $\mathcal{P}$  with equation  $x_{d+1} = \sum_{i \in [d]} x_i^2$ .

lifting function  $\mathbf{p} \in \mathbb{R}^d \mapsto \hat{\mathbf{p}} = (\mathbf{p}, \|\mathbf{p}\|^2) \in \mathbb{R}^{d+1}$ .

**PROP.** The Voronoi diagram  $\text{Vor}(\mathbf{P})$  is the vertical projection of the upper envelope of the planes tangent to the paraboloid  $\mathcal{P}$  at the lifted points  $\hat{\mathbf{p}}$  for  $\mathbf{p} \in \mathbf{P}$ .

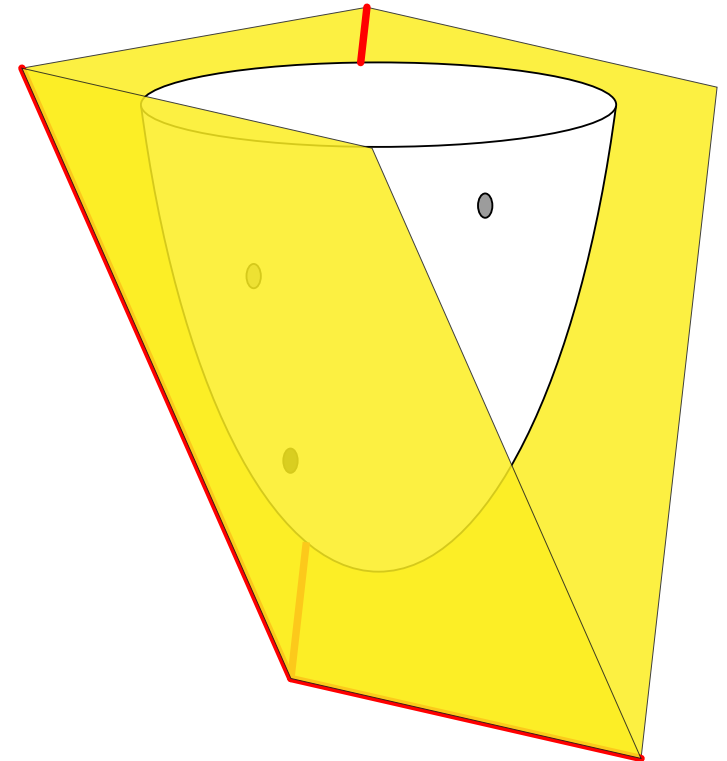

# LIFTING POINTS ON THE PARABOLOID

paraboloid  $\mathcal{P}$  with equation  $x_{d+1} = \sum_{i \in [d]} x_i^2$ .

lifting function  $\mathbf{p} \in \mathbb{R}^d \mapsto \hat{\mathbf{p}} = (\mathbf{p}, \|\mathbf{p}\|^2) \in \mathbb{R}^{d+1}$ .

**PROP.** The Voronoi diagram  $\text{Vor}(\mathbf{P})$  is the vertical projection of the upper envelope of the planes tangent to the paraboloid  $\mathcal{P}$  at the lifted points  $\hat{\mathbf{p}}$  for  $\mathbf{p} \in \mathbf{P}$ .

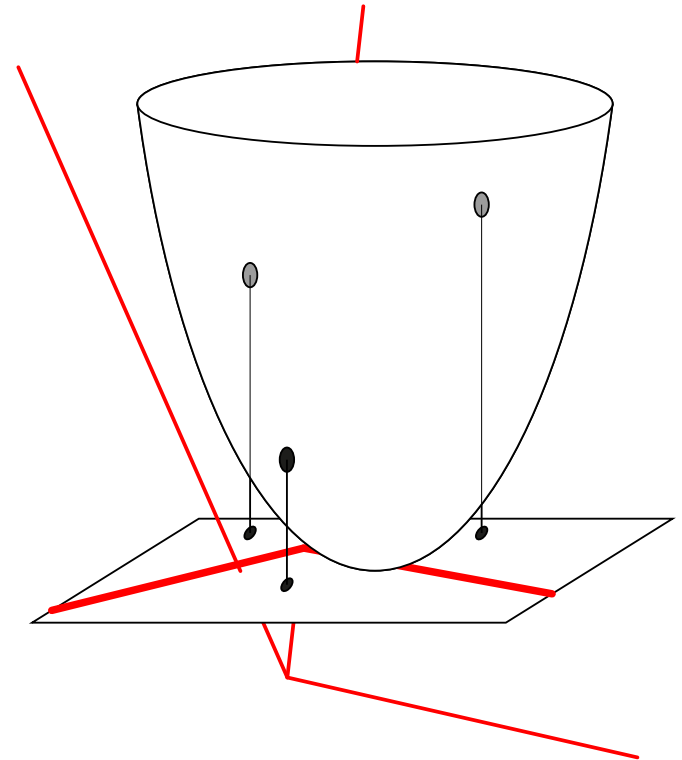



# LIFTING POINTS ON THE PARABOLOID

paraboloid  $\mathcal{P}$  with equation  $x_{d+1} = \sum_{i \in [d]} x_i^2$ .

lifting function  $\mathbf{p} \in \mathbb{R}^d \mapsto \hat{\mathbf{p}} = (\mathbf{p}, \|\mathbf{p}\|^2) \in \mathbb{R}^{d+1}$ .

**PROP.** The Voronoi diagram  $\text{Vor}(\mathbf{P})$  is the vertical projection of the upper envelope of the planes tangent to the paraboloid  $\mathcal{P}$  at the lifted points  $\hat{\mathbf{p}}$  for  $\mathbf{p} \in \mathbf{P}$ .

proof:  $H(\mathbf{p}) =$  tangent plane to the paraboloid  $\mathcal{P}$  at  $\hat{\mathbf{p}}$ .  
= plane of equation  $x_{d+1} = 2 \langle \mathbf{p} \mid \mathbf{x} \rangle - \|\mathbf{p}\|^2$ .

Therefore,  $H(\mathbf{p})$  above  $H(\mathbf{q})$  at point  $\mathbf{x} \iff \|\mathbf{x} - \mathbf{p}\| \leq \|\mathbf{x} - \mathbf{q}\|$ .

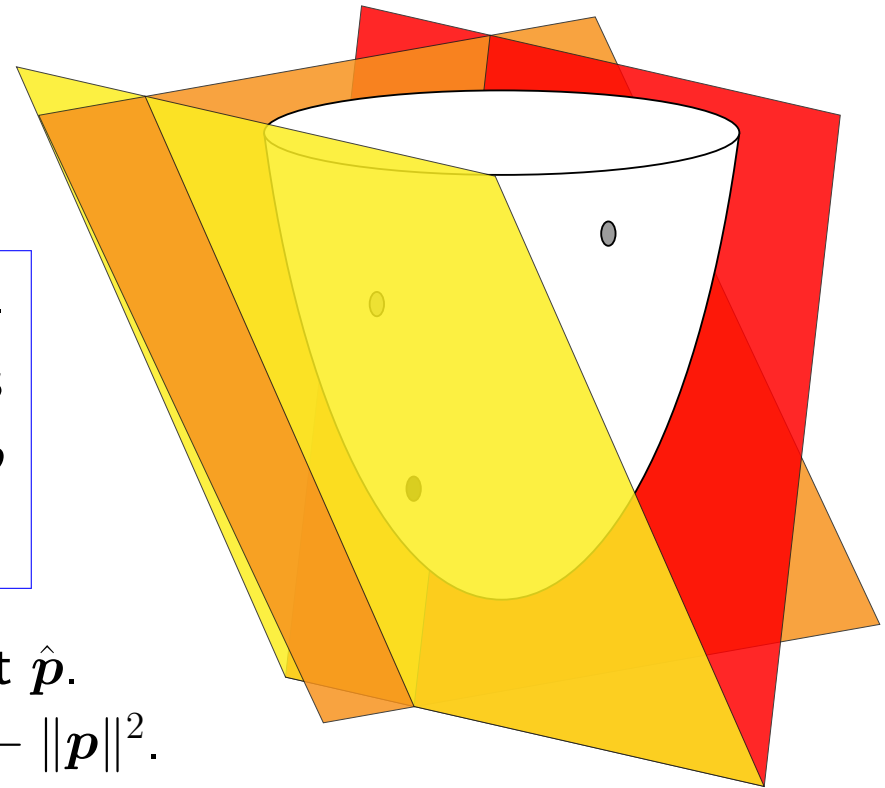

# DELAUNAY COMPLEX

**DEF.**  $P$  = set of sites in  $\mathbb{R}^n$ .

Voronoi region  $\text{Vor}(\mathbf{p}, \mathbf{P}) = \{ \mathbf{x} \in \mathbb{R}^2 \mid \|\mathbf{x} - \mathbf{p}\| \leq \|\mathbf{x} - \mathbf{q}\| \text{ for all } \mathbf{q} \in \mathbf{P} \}$ .

Voronoi diagram  $\text{Vor}(\mathbf{P}) = \text{partition of } \mathbb{R}^n \text{ formed by } \text{Vor}(\mathbf{p}, \mathbf{P}) \text{ for } \mathbf{p} \in \mathbf{P}$ .

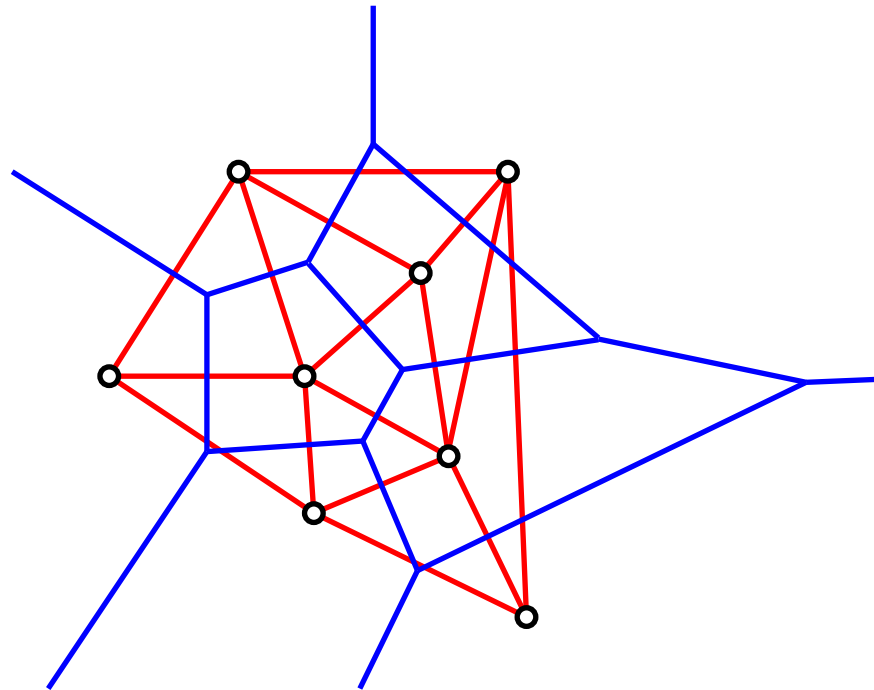

**DEF.** Delaunay complex  $\text{Del}(\mathbf{P}) = \text{intersection complex of } \text{Vor}(\mathbf{P})$

$$\text{Del}(\mathbf{P}) = \left\{ \text{conv}(\mathbf{X}) \mid \mathbf{X} \subseteq \mathbf{P} \text{ and } \bigcap_{\mathbf{p} \in \mathbf{X}} \text{Vor}(\mathbf{p}, \mathbf{P}) \neq \emptyset \right\}.$$

# EMPTY CIRCLES

**PROP.** For any three points  $p, q, r$  of  $P$ ,

- $pq$  is an edge of  $\text{Del}(P) \iff$  there is an empty circle passing through  $p$  and  $q$ ,
- $pqr$  is a triangle of  $\text{Del}(P) \iff$  the circumcircle of  $p, q, r$  is empty.

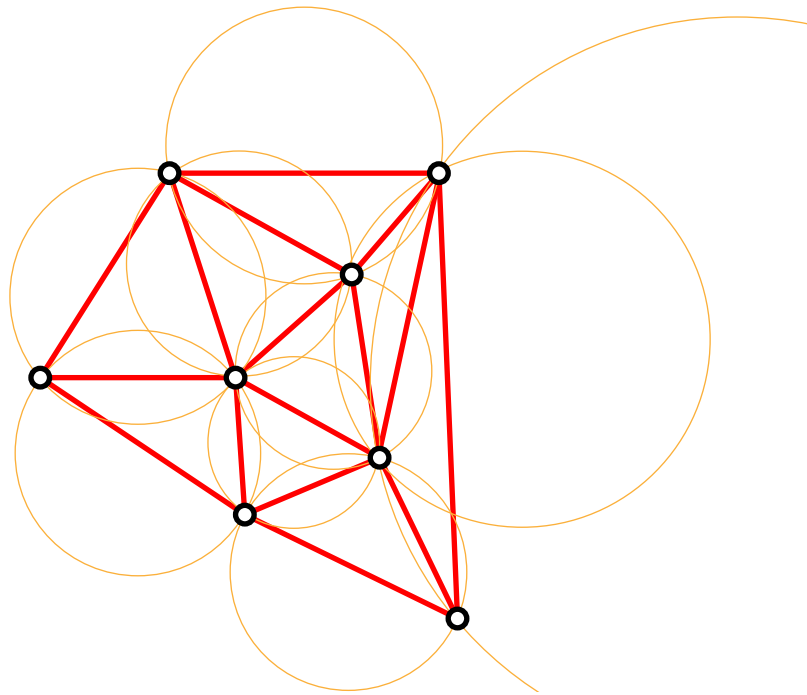

proof idea: consider the circle centered at the intersection of the Voronoi regions and passing through the Voronoi sites.

# EMPTY CIRCLES

**PROP.** For any three points  $p, q, r$  of  $P$ ,

- $pq$  is an edge of  $\text{Del}(P) \iff$  there is an empty circle passing through  $p$  and  $q$ ,
- $pqr$  is a triangle of  $\text{Del}(P) \iff$  the circumcircle of  $p, q, r$  is an empty circle.

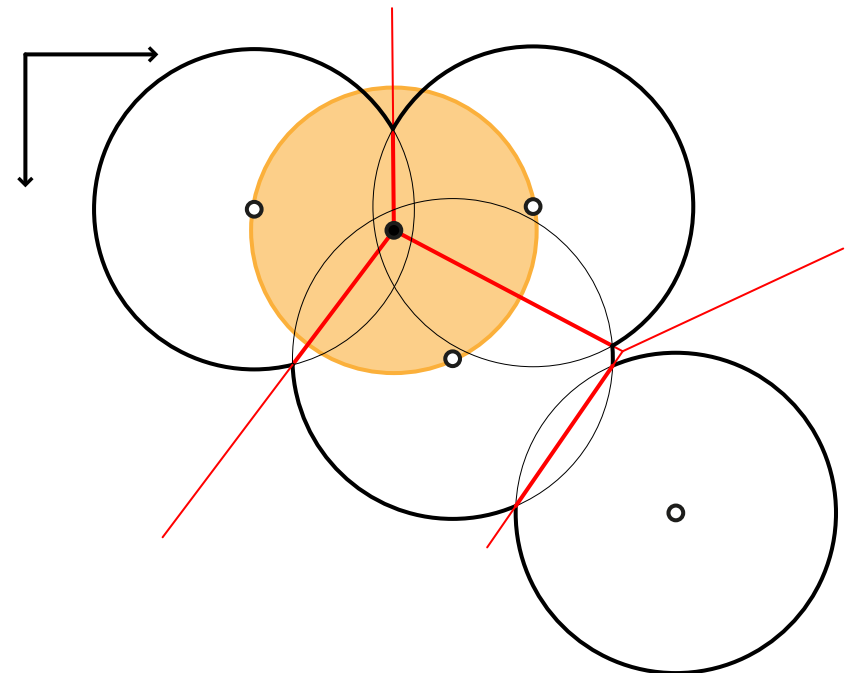
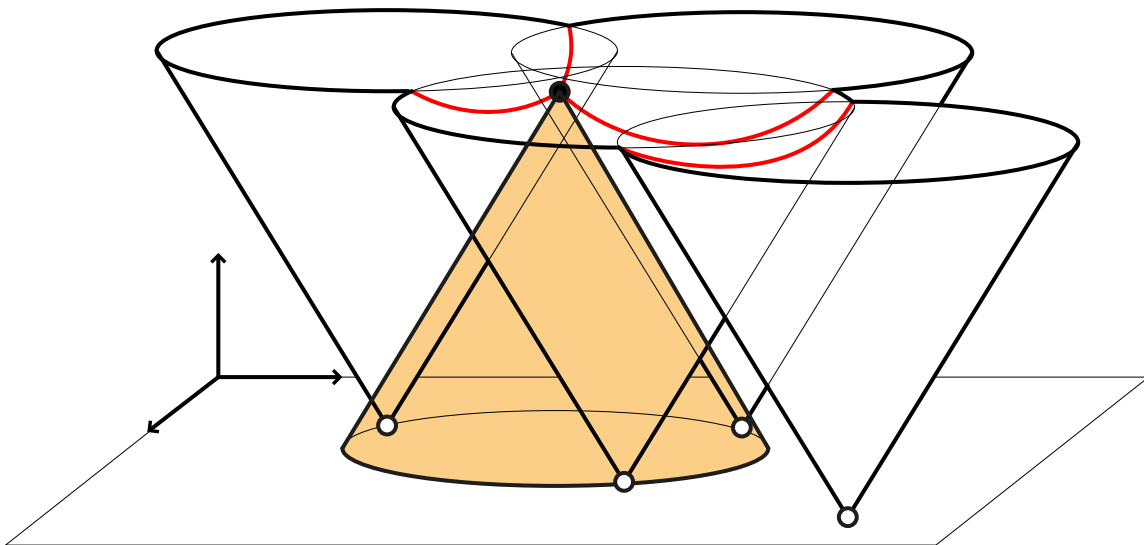

# LIFTING POINTS ON THE PARABOLOID

---

paraboloid  $\mathcal{P}$  with equation  $x_{d+1} = \sum_{i \in [d]} x_i^2$ .

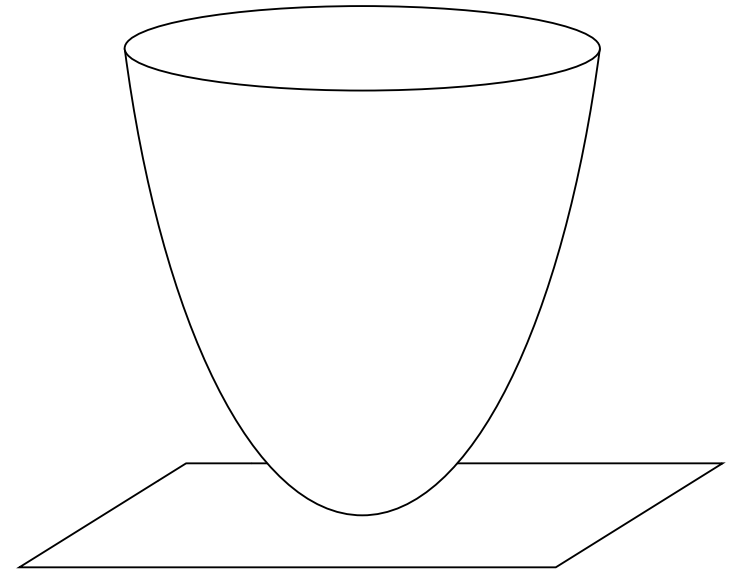

# LIFTING POINTS ON THE PARABOLOID

---

paraboloid  $\mathcal{P}$  with equation  $x_{d+1} = \sum_{i \in [d]} x_i^2$ .

lifting function  $\mathbf{p} \in \mathbb{R}^d \mapsto \hat{\mathbf{p}} = (\mathbf{p}, \|\mathbf{p}\|^2) \in \mathbb{R}^{d+1}$ .

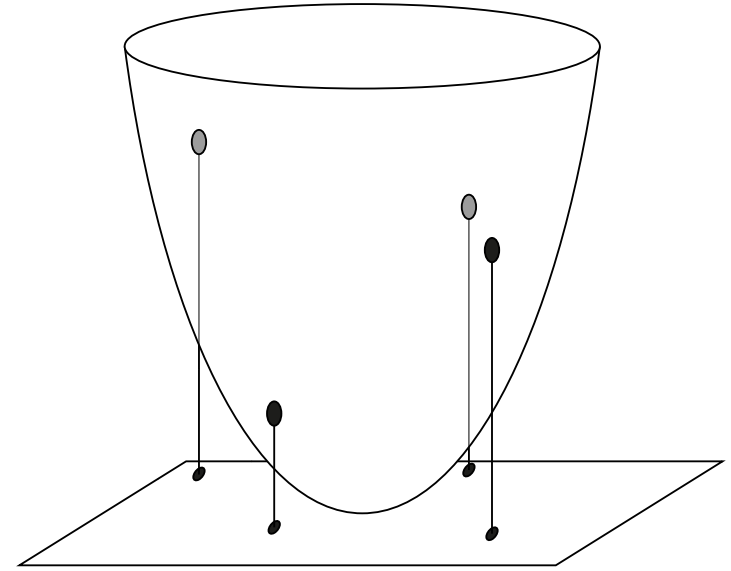

# LIFTING POINTS ON THE PARABOLOID

paraboloid  $\mathcal{P}$  with equation  $x_{d+1} = \sum_{i \in [d]} x_i^2$ .

lifting function  $\mathbf{p} \in \mathbb{R}^d \mapsto \hat{\mathbf{p}} = (\mathbf{p}, \|\mathbf{p}\|^2) \in \mathbb{R}^{d+1}$ .

**PROP.** The Delaunay complex  $\text{Del}(\mathbf{P})$  is the vertical projection of the lower convex hull of the lifted points  $\hat{\mathbf{p}}$  for  $\mathbf{p} \in \mathbf{P}$ .

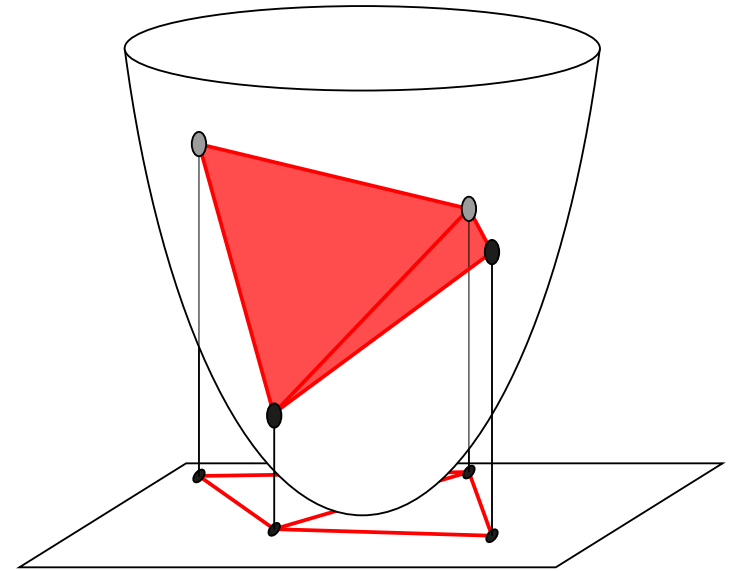

# LIFTING POINTS ON THE PARABOLOID

paraboloid  $\mathcal{P}$  with equation  $x_{d+1} = \sum_{i \in [d]} x_i^2$ .

lifting function  $\mathbf{p} \in \mathbb{R}^d \mapsto \hat{\mathbf{p}} = (\mathbf{p}, \|\mathbf{p}\|^2) \in \mathbb{R}^{d+1}$ .

**PROP.** The Delaunay complex  $\text{Del}(\mathbf{P})$  is the vertical projection of the lower convex hull of the lifted points  $\hat{\mathbf{p}}$  for  $\mathbf{p} \in \mathbf{P}$ .

proof: Paraboloid cap below a hyperplane:

$$x_{d+1} = \sum_{i \in [d]} x_i^2 \quad \text{and} \quad x_{d+1} \leq \sum_{i \in [d]} \lambda_i x_i.$$

Projection of this cap:

$$\sum_{i \in [d]} (x_i - \lambda_i/2)^2 \leq \sum_{i \in [d]} \lambda_i^2/4.$$

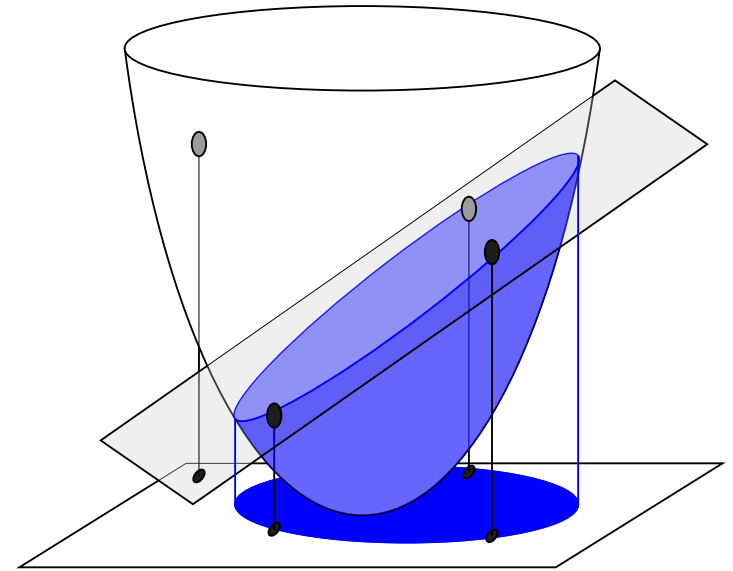



# LIFTING POINTS ON THE PARABOLOID

paraboloid  $\mathcal{P}$  with equation  $x_{d+1} = \sum_{i \in [d]} x_i^2$ .

lifting function  $\mathbf{p} \in \mathbb{R}^d \mapsto \hat{\mathbf{p}} = (\mathbf{p}, \|\mathbf{p}\|^2) \in \mathbb{R}^{d+1}$ .

**PROP.** The Delaunay complex  $\text{Del}(\mathbf{P})$  is the vertical projection of the lower convex hull of the lifted points  $\hat{\mathbf{p}}$  for  $\mathbf{p} \in \mathbf{P}$ .

proof: Paraboloid cap below a hyperplane:

$$x_{d+1} = \sum_{i \in [d]} x_i^2 \quad \text{and} \quad x_{d+1} \leq \sum_{i \in [d]} \lambda_i x_i.$$

Projection of this cap:

$$\sum_{i \in [d]} (x_i - \lambda_i/2)^2 \leq \sum_{i \in [d]} \lambda_i^2/4.$$

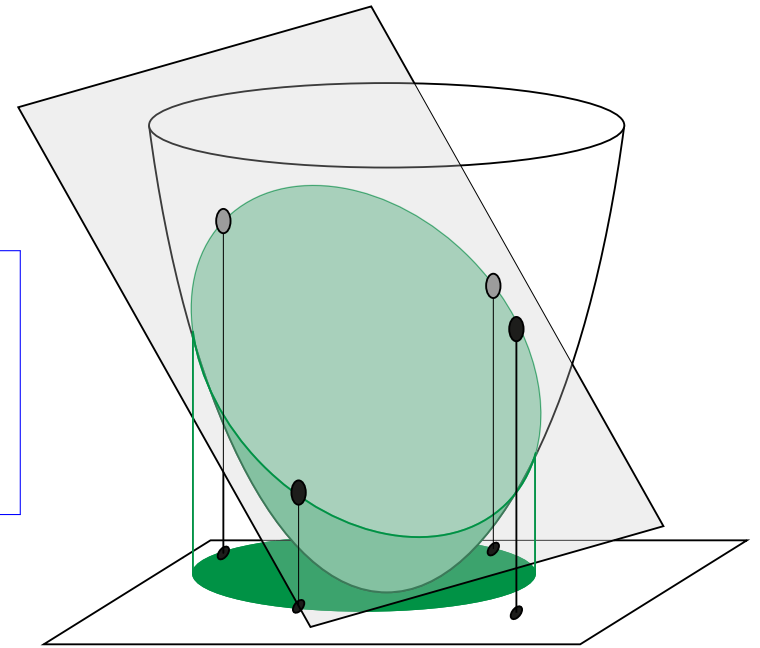

# LIFTING POINTS ON THE PARABOLOID

paraboloid  $\mathcal{P}$  with equation  $x_{d+1} = \sum_{i \in [d]} x_i^2$ .

lifting function  $\mathbf{p} \in \mathbb{R}^d \mapsto \hat{\mathbf{p}} = (\mathbf{p}, \|\mathbf{p}\|^2) \in \mathbb{R}^{d+1}$ .

**PROP.** The Delaunay complex  $\text{Del}(\mathbf{P})$  is the vertical projection of the lower convex hull of the lifted points  $\hat{\mathbf{p}}$  for  $\mathbf{p} \in \mathbf{P}$ .

proof: Paraboloid cap below a hyperplane:

$$x_{d+1} = \sum_{i \in [d]} x_i^2 \quad \text{and} \quad x_{d+1} \leq \sum_{i \in [d]} \lambda_i x_i.$$

Projection of this cap:

$$\sum_{i \in [d]} (x_i - \lambda_i/2)^2 \leq \sum_{i \in [d]} \lambda_i^2/4.$$

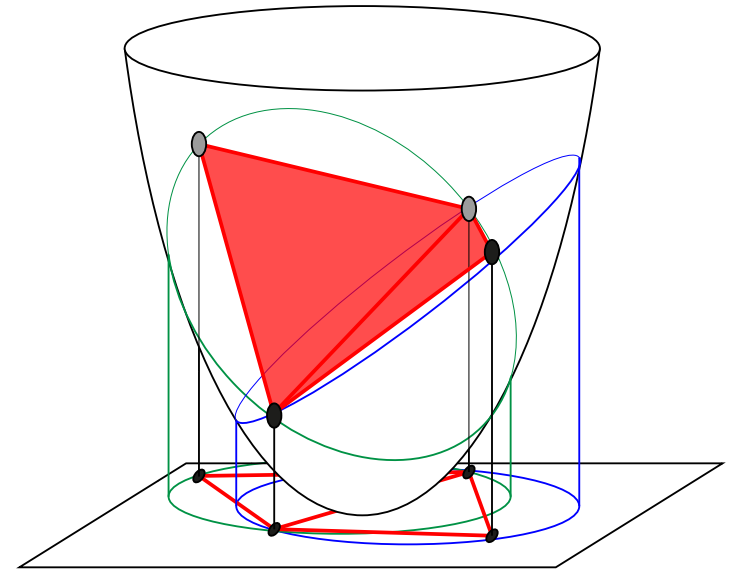

## LAWSON FLIPS IN DIMENSION 2

**DEF.** Lawson flip = flip of an edge  $pq$  contained in two triangles  $pqr$  and  $pqs$  such that  $s$  is inside the circumcircle of  $pqr$  and  $r$  is inside the circumcircle of  $pqs$ .

**PROP.** Lawson flips are always possible, and lead to the Delaunay triangulation.

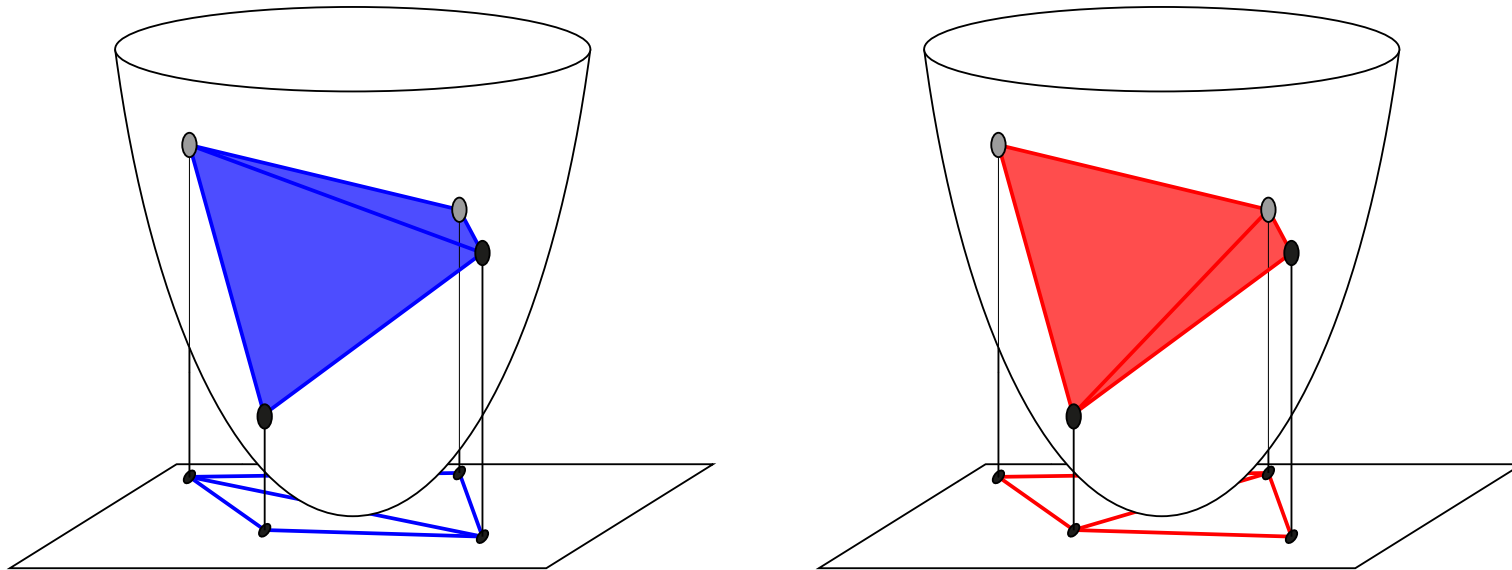

**CORO.** For any 2-dimensional point configuration, the flip graph is connected.

**THM.** (Santos) In dimension  $\geq 5$ , some point sets have disconnected flip graphs.

---

# REGULAR TRIANGULATIONS & SUBDIVISIONS

---

# LIFTINGS AND REGULAR SUBDIVISIONS

DEF.  $P =$  point configuration.  $h : P \rightarrow \mathbb{R}$  height function.

$\mathcal{S}(P, h) =$  subdivision of  $P$  obtained as the projection of the lower convex hull of the lifted point set  $\{(p, h(p)) \mid p \in P\}$ .

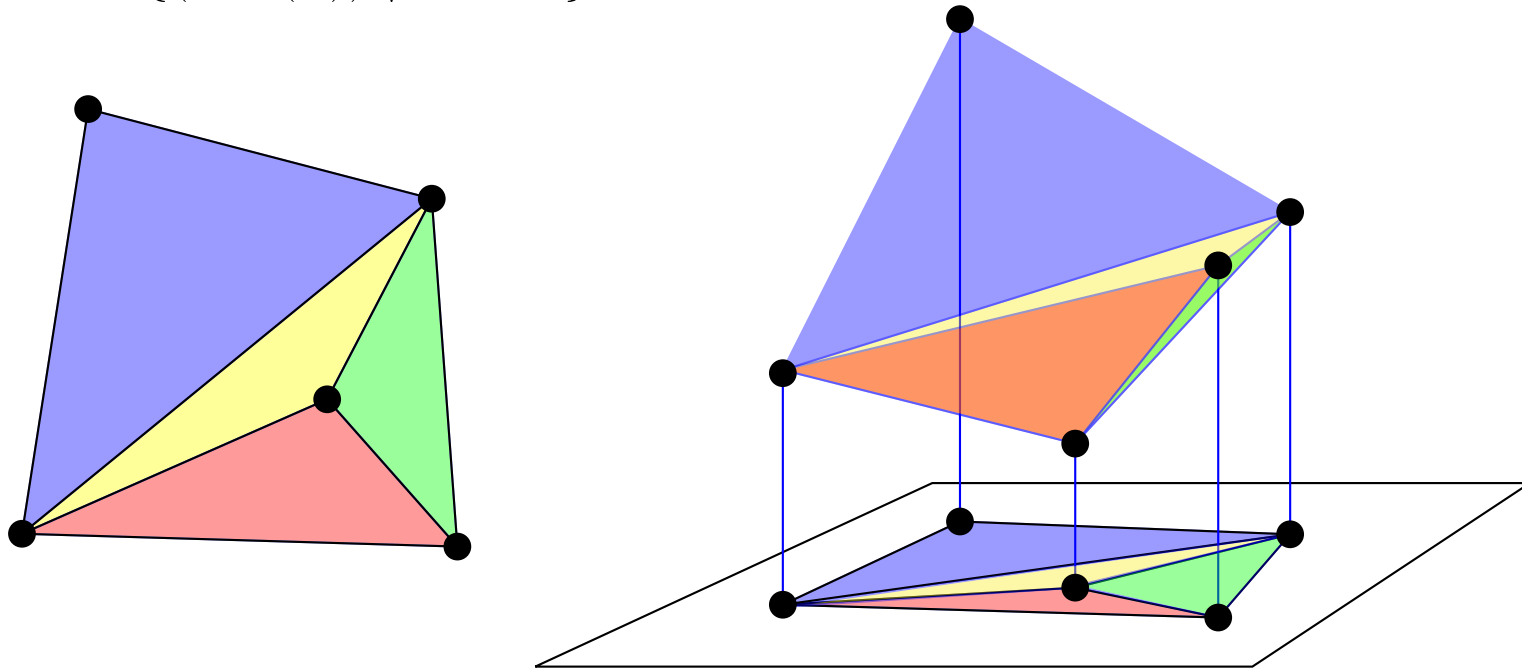

A subdivision  $\mathcal{S}$  is regular if there is a height function  $h : P \rightarrow \mathbb{R}$  st  $\mathcal{S} = \mathcal{S}(P, h)$ .

PROP. If  $g : \mathbb{R}^n \rightarrow \mathbb{R}$  is affine, then  $\mathcal{S}(P, g + h) = \mathcal{S}(P, h)$  for any  $h : P \rightarrow \mathbb{R}$ .

# LIFTINGS AND REGULAR SUBDIVISIONS

DEF.  $P =$  point configuration.  $h : P \rightarrow \mathbb{R}$  height function.

$\mathcal{S}(P, h) =$  subdivision of  $P$  obtained as the projection of the lower convex hull of the lifted point set  $\{(p, h(p)) \mid p \in P\}$ .

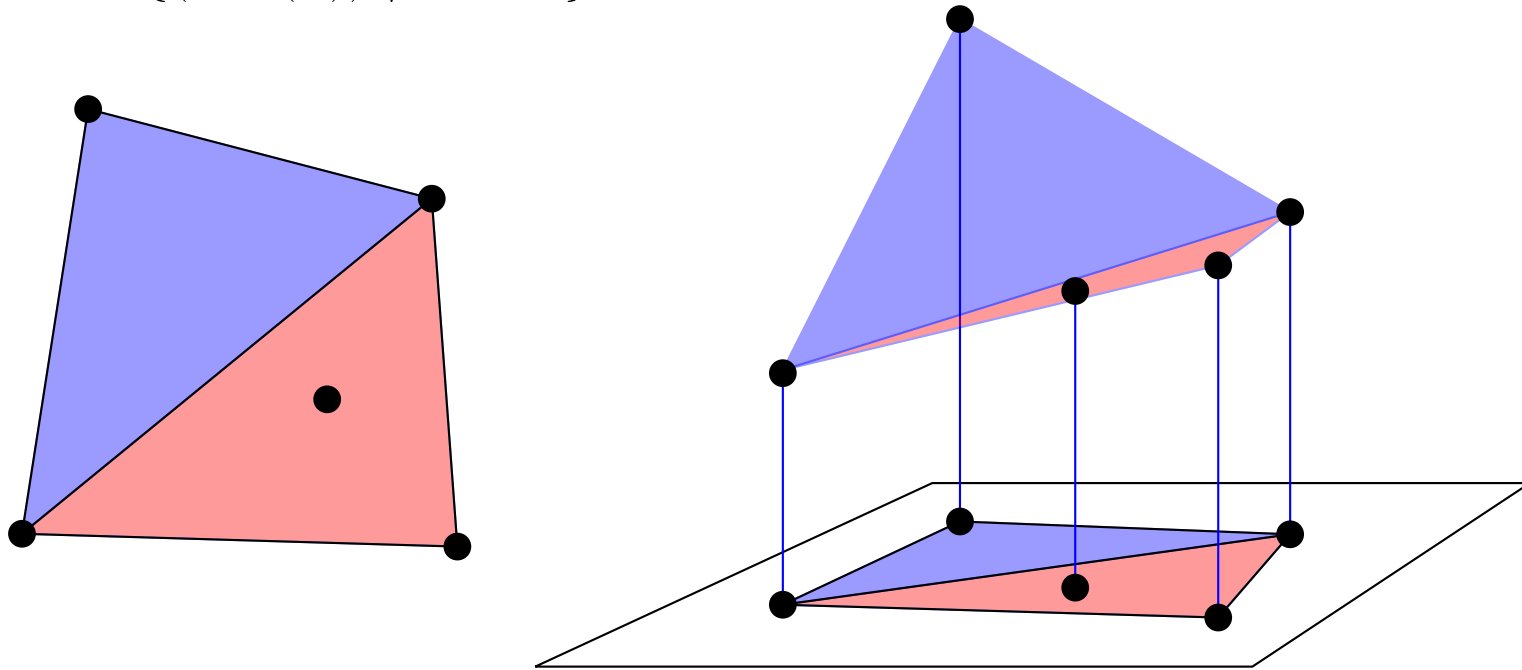

A subdivision  $\mathcal{S}$  is regular if there is a height function  $h : P \rightarrow \mathbb{R}$  st  $\mathcal{S} = \mathcal{S}(P, h)$ .

PROP. If  $g : \mathbb{R}^n \rightarrow \mathbb{R}$  is affine, then  $\mathcal{S}(P, g + h) = \mathcal{S}(P, h)$  for any  $h : P \rightarrow \mathbb{R}$ .

# LIFTINGS AND REGULAR SUBDIVISIONS

DEF.  $P =$  point configuration.  $h : P \rightarrow \mathbb{R}$  height function.

$\mathcal{S}(P, h) =$  subdivision of  $P$  obtained as the projection of the lower convex hull of the lifted point set  $\{(p, h(p)) \mid p \in P\}$ .

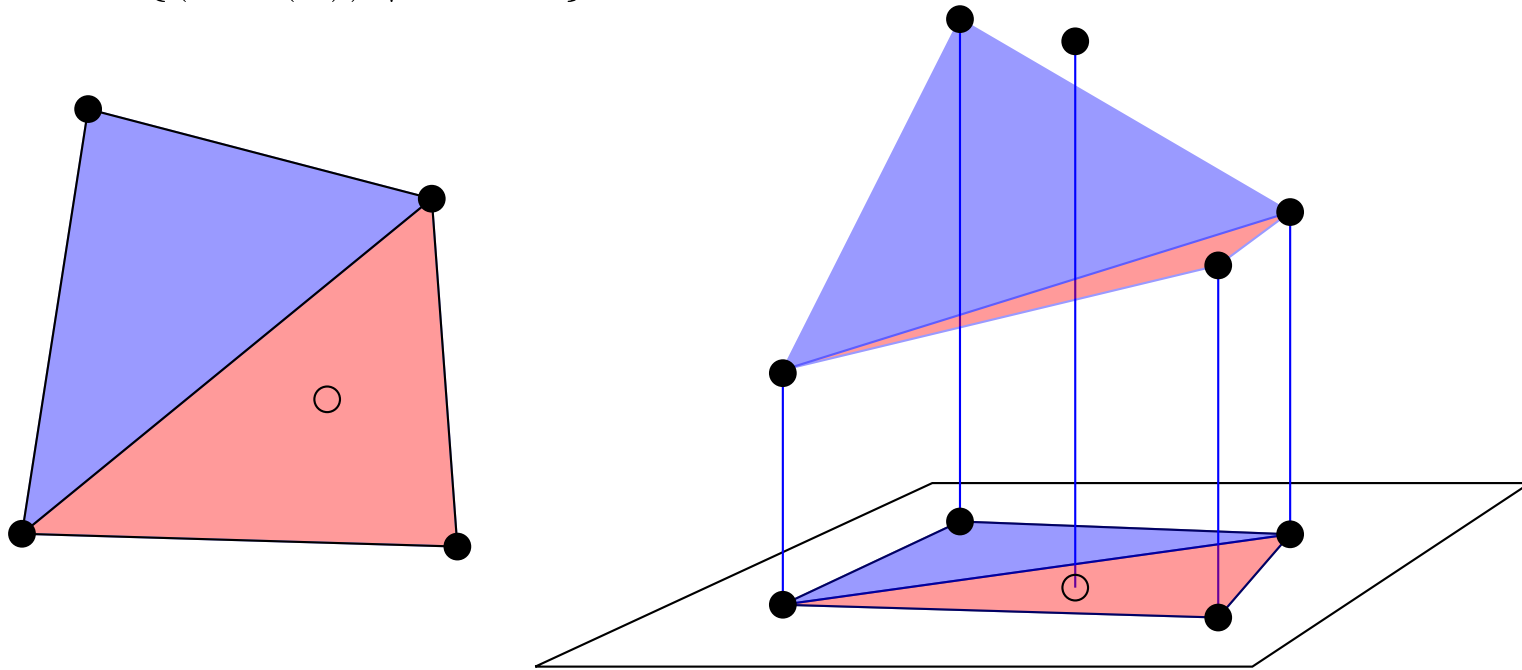

A subdivision  $\mathcal{S}$  is regular if there is a height function  $h : P \rightarrow \mathbb{R}$  st  $\mathcal{S} = \mathcal{S}(P, h)$ .

PROP. If  $g : \mathbb{R}^n \rightarrow \mathbb{R}$  is affine, then  $\mathcal{S}(P, g + h) = \mathcal{S}(P, h)$  for any  $h : P \rightarrow \mathbb{R}$ .

# EXM OF REGULAR SUBDIVISIONS

Point configuration  $P = \{(0, 0), (3, 0), (0, 3), (3, 3), (1, 1)\}$ .

Restrict to height functions  $h$  with  $h((0, 0)) = h((3, 0)) = h((0, 3)) = 0$ .

Let  $x = h((3, 3))$  and  $y = h((1, 1))$ .

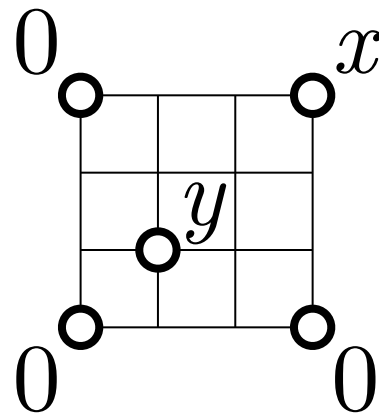

QU. Give conditions on  $x$  and  $y$  to obtain the following regular subdivisions:

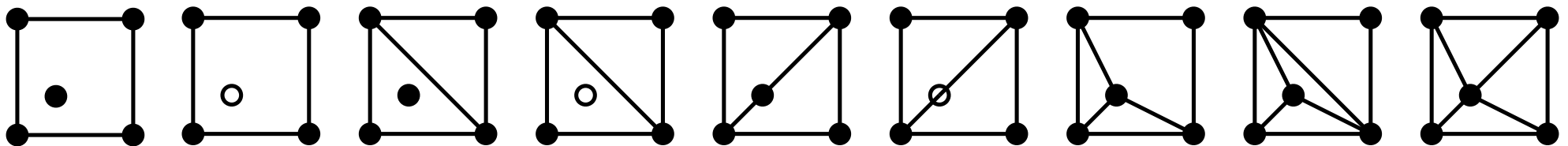



# EXM OF REGULAR SUBDIVISIONS

Point configuration  $P = \{(0, 0), (3, 0), (0, 3), (3, 3), (1, 1)\}$ .

Restrict to height functions  $h$  with  $h((0, 0)) = h((3, 0)) = h((0, 3)) = 0$ .

Let  $x = h((3, 3))$  and  $y = h((1, 1))$ .

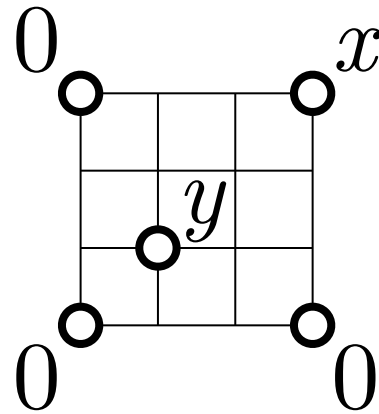

**QU.** Give conditions on  $x$  and  $y$  to obtain the following regular subdivisions:

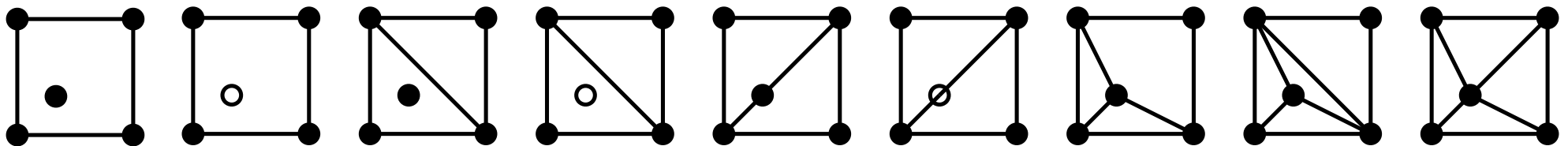

$x = 0$        $x = 0$

$y = 0$        $y > 0$

# EXM OF REGULAR SUBDIVISIONS

Point configuration  $P = \{(0, 0), (3, 0), (0, 3), (3, 3), (1, 1)\}$ .

Restrict to height functions  $h$  with  $h((0, 0)) = h((3, 0)) = h((0, 3)) = 0$ .

Let  $x = h((3, 3))$  and  $y = h((1, 1))$ .

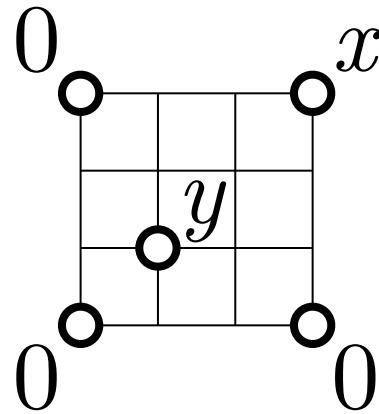

**QU.** Give conditions on  $x$  and  $y$  to obtain the following regular subdivisions:

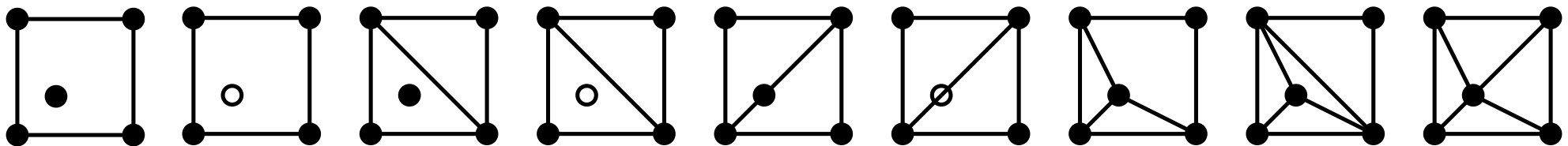

$x = 0$	$x = 0$	$x > 0$	$x > 0$
$y = 0$	$y > 0$	$y = 0$	$y > 0$

# EXM OF REGULAR SUBDIVISIONS

Point configuration  $P = \{(0, 0), (3, 0), (0, 3), (3, 3), (1, 1)\}$ .

Restrict to height functions  $h$  with  $h((0, 0)) = h((3, 0)) = h((0, 3)) = 0$ .

Let  $x = h((3, 3))$  and  $y = h((1, 1))$ .

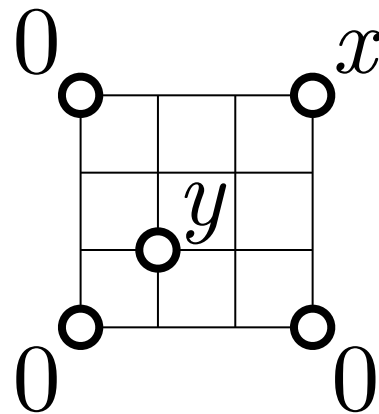

**QU.** Give conditions on  $x$  and  $y$  to obtain the following regular subdivisions:

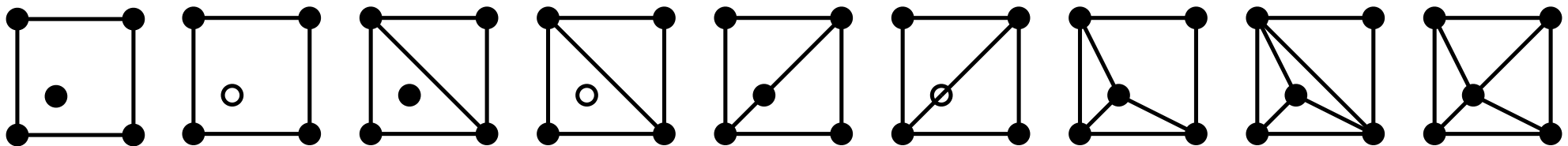

$x = 0$	$x = 0$	$x > 0$	$x > 0$	$x < 0$	$x < 0$	$x - 3y = 0$	$x - 3y < 0$	$x - 3y < 0$
$y = 0$	$y > 0$	$y = 0$	$y > 0$	$x - 3y = 0$	$x - 3y < 0$	$x - 3y < 0$	$x - 3y < 0$	$x - 3y < 0$

# EXM OF REGULAR SUBDIVISIONS

Point configuration  $P = \{(0, 0), (3, 0), (0, 3), (3, 3), (1, 1)\}$ .

Restrict to height functions  $h$  with  $h((0, 0)) = h((3, 0)) = h((0, 3)) = 0$ .

Let  $x = h((3, 3))$  and  $y = h((1, 1))$ .

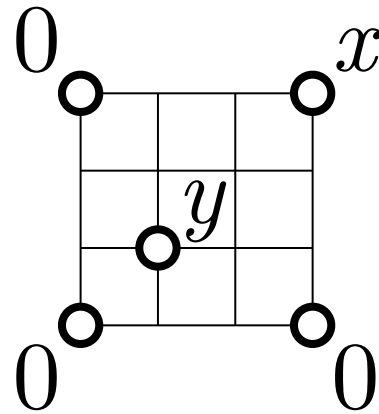

**QU.** Give conditions on  $x$  and  $y$  to obtain the following regular subdivisions:

$x = 0$	$x = 0$	$x > 0$	$x > 0$	$x < 0$	$x < 0$	$x + 3y = 0$	$x + 3y > 0$	$x + 3y < 0$
$y = 0$	$y > 0$	$y = 0$	$y > 0$	$x - 3y = 0$	$x - 3y < 0$	$y < 0$	$y < 0$	$x - 3y > 0$

# NON REGULAR TRIANGULATIONS

QU. Show that the following two triangulations are not regular:

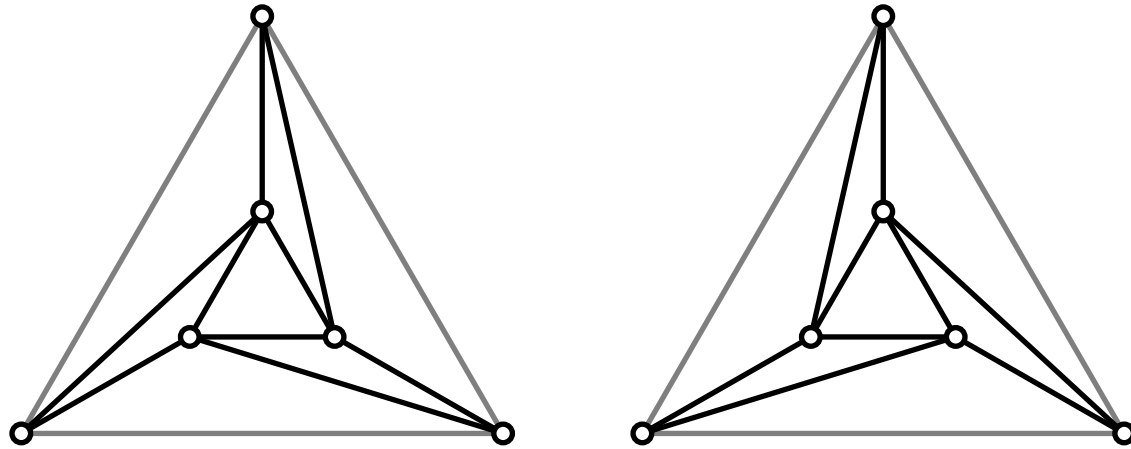

# NON REGULAR TRIANGULATIONS

**PROP.** The following two triangulations are not regular:

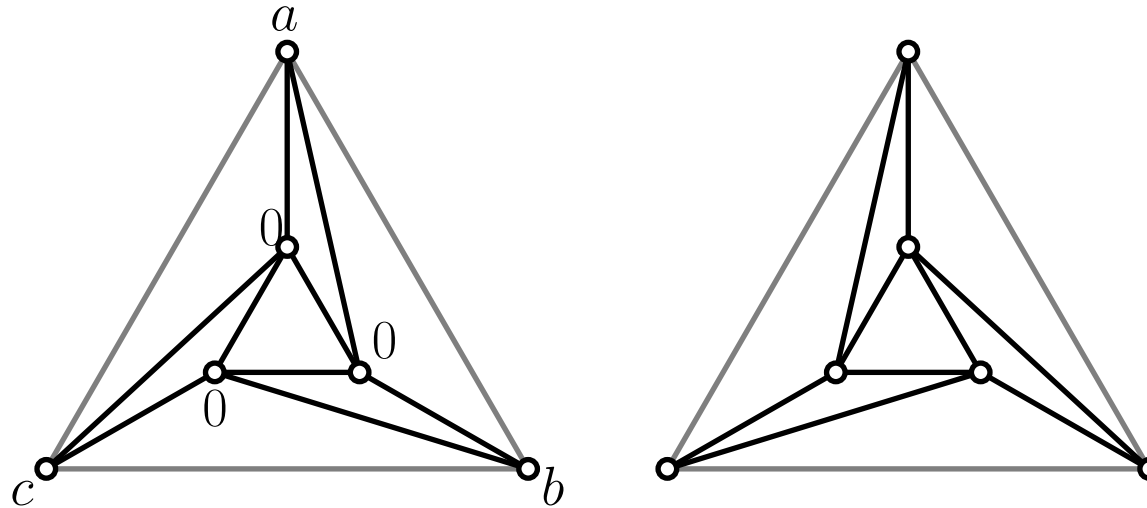

proof: assume the left one regular,  
and pick a height function.

Up to an affine function, height 3  
for the 3 internal vertices.

The heights of the 3 external  
vertices satisfy:  $a < b < c < a$ .

Contradiction.

# NON REGULAR TRIANGULATIONS

**PROP.** The following two triangulations are not regular:

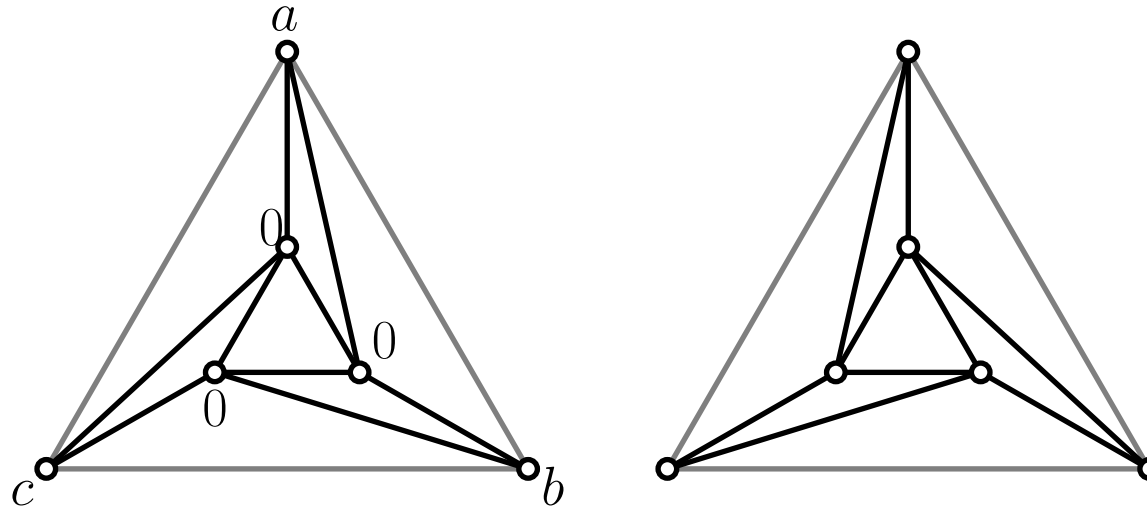

proof: assume the left one regular,  
and pick a height function.

Up to an affine function, height 3  
for the 3 internal vertices.

The heights of the 3 external  
vertices satisfy:  $a < b < c < a$ .

Contradiction.

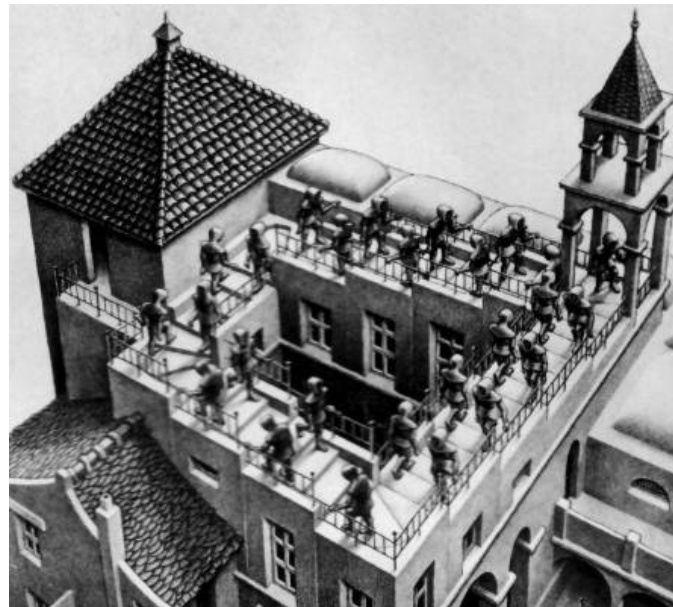

## CONVEX POSITION

---

QU. Show that all subdivisions of a planar point set in convex position are regular.

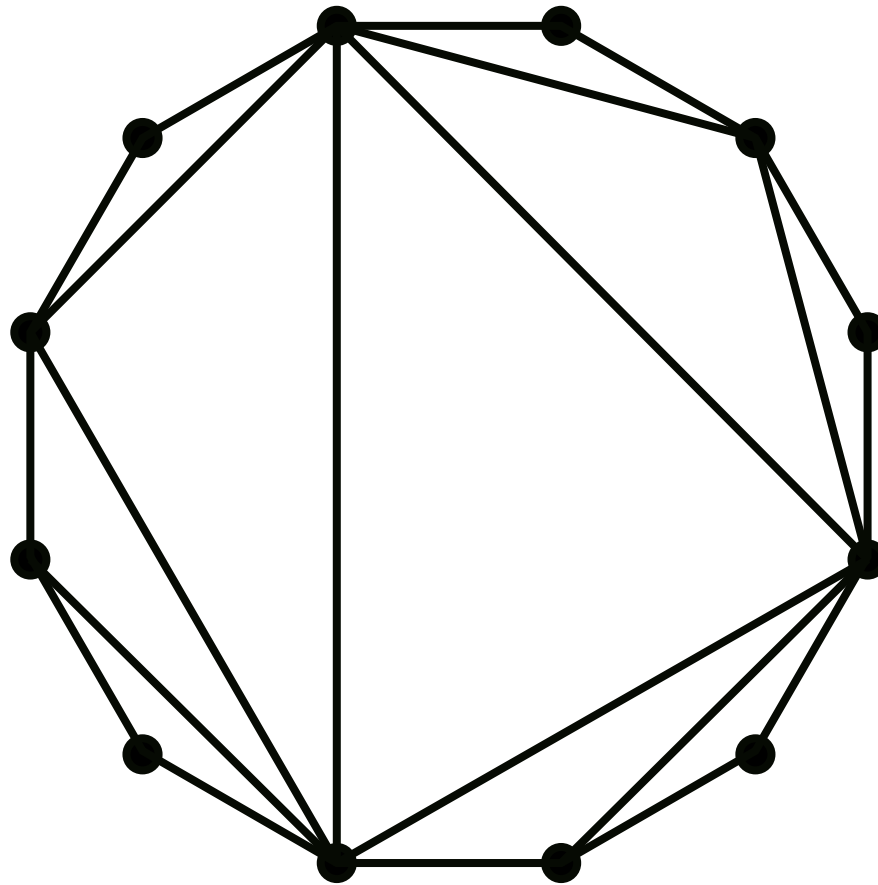



# CONVEX POSITION

**PROP.** All subdivisions of a planar point set in convex position are regular.

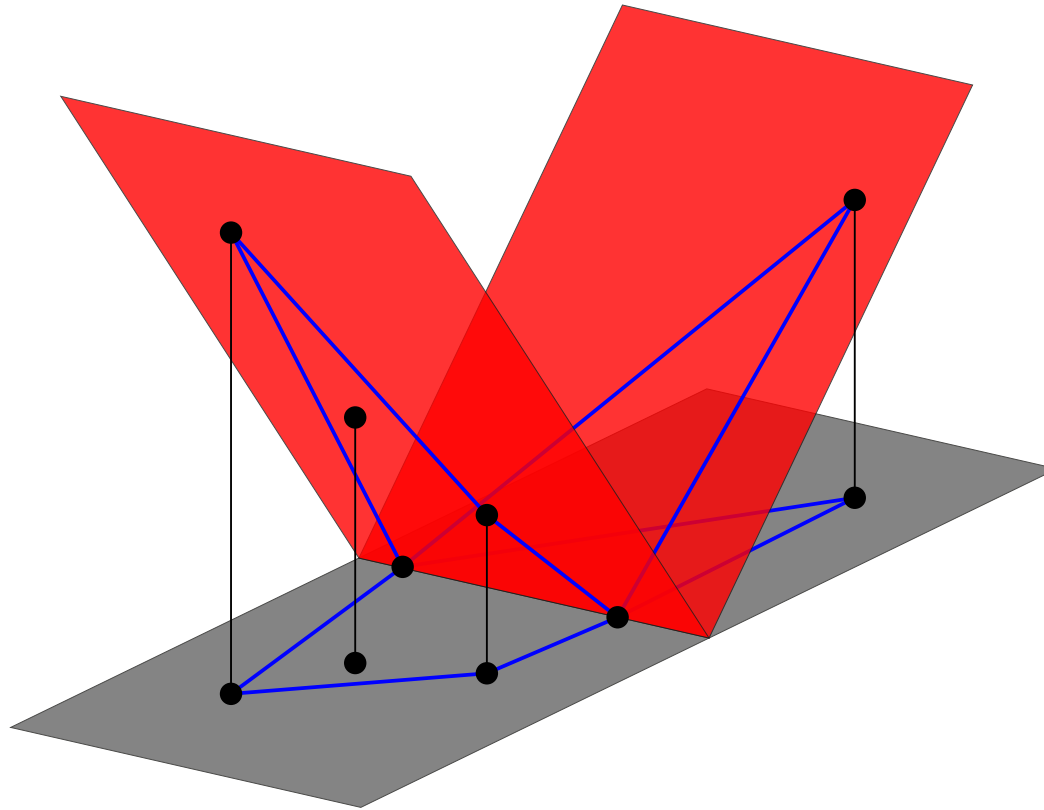

Use  $h(\mathbf{p}) = \sum_{\delta \in \mathcal{S}} d(\delta, \mathbf{p})$  where  $d(\delta, \mathbf{p})$  is the distance of  $\mathbf{p}$  to the line spanned by  $\delta$ .

# REGULAR SUBDIVISION LATTICE

DEF.  $\mathcal{S}$  refines  $\mathcal{S}'$  when for any  $X \in \mathcal{S}$ , there is  $X' \in \mathcal{S}'$  st  $X \subseteq X'$ .  
regular subdivision lattice = regular subdivisions of  $P$  ordered by refinement.

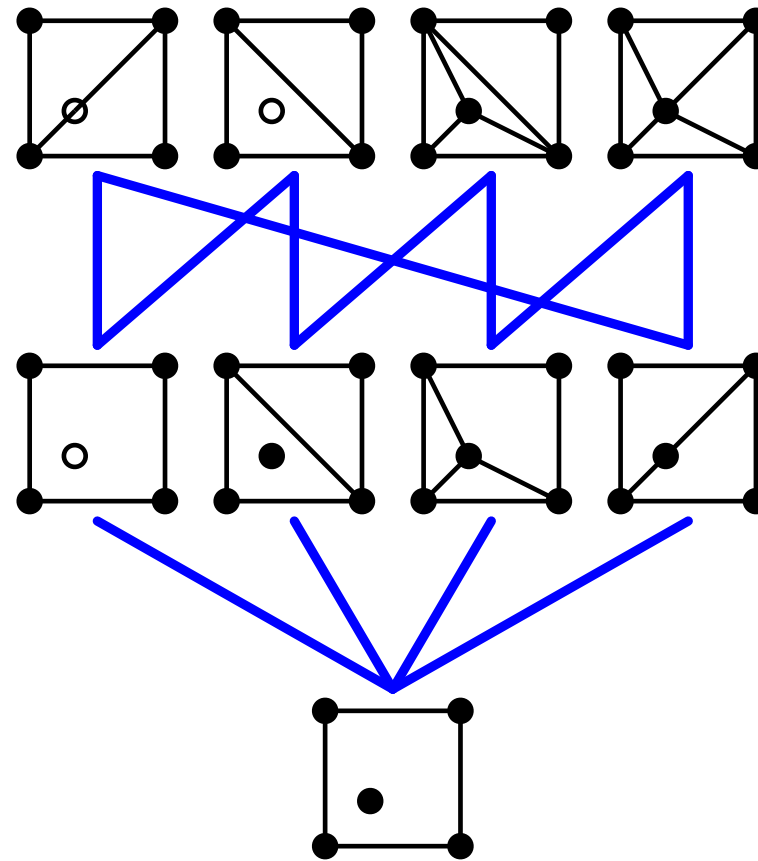

---

# SECONDARY FAN AND POLYTOPE

---

# SECONDARY FAN

**DEF.** secondary cone of subdivision  $\mathcal{S}$  of  $P = \Sigma\mathbb{C}(\mathcal{S}) = \{h \in \mathbb{R}^P \mid \mathcal{S}(P, h) = \mathcal{S}\}$ .  
secondary fan of  $P =$  fan formed by the secondary cones of all (regular) subdivisions.

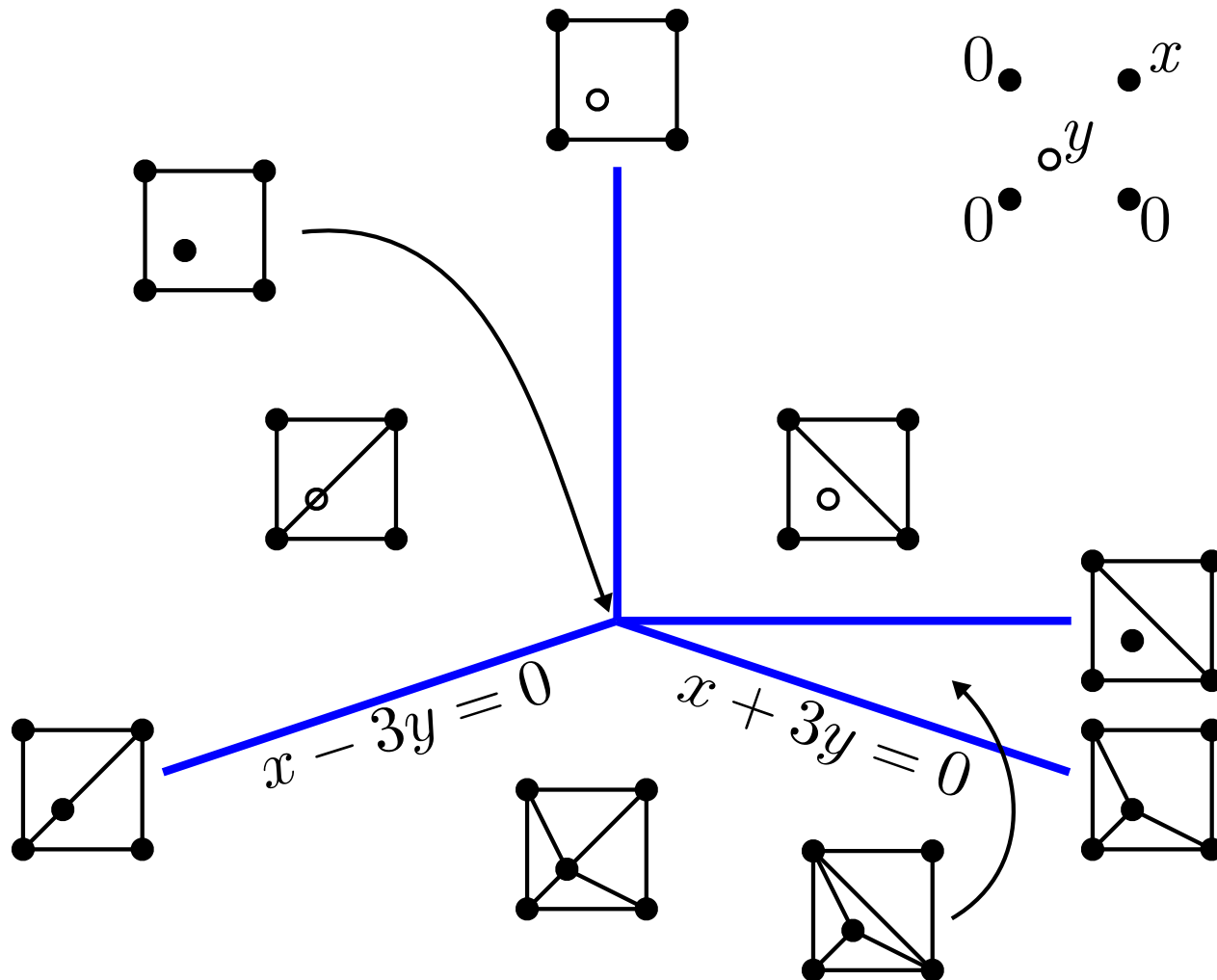

# SECONDARY POLYTOPE

**DEF.**  $\mathcal{T}$  triangulation of a point set  $P \subseteq \mathbb{R}^d$ .  
volume vector of  $\mathcal{T}$ :

$$\Phi(\mathcal{T}) = \left( \sum_{p \in \Delta \in \mathcal{T}} \text{vol}(\Delta) \right)_{p \in P}$$

secondary polytope of  $P$ :

$$\Sigma\mathbb{P}(P) := \text{conv} \{ \Phi(\mathcal{T}) \mid \mathcal{T} \text{ triangulation of } P \}.$$

exm:

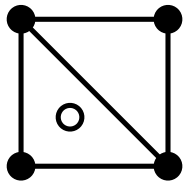

(9, 18, 18, 9, 0)

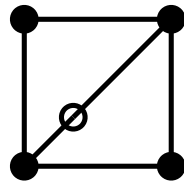

(18, 9, 9, 18, 0)

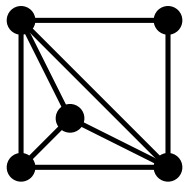

(6, 15, 15, 9, 9)

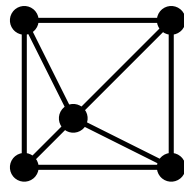

(6, 9, 9, 12, 18)

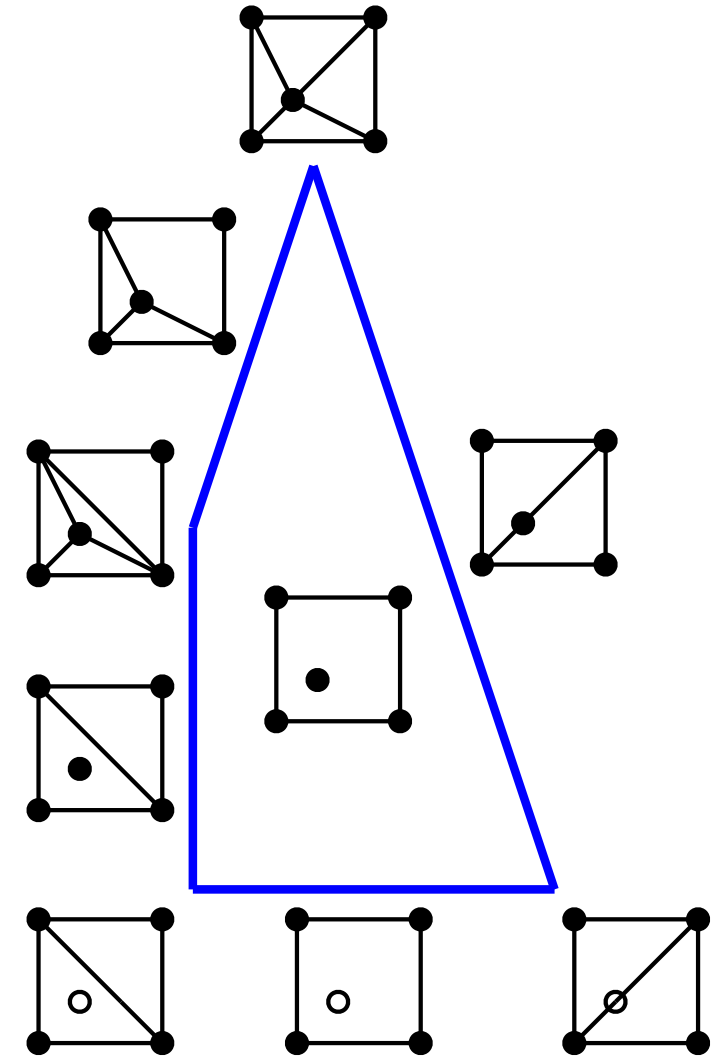

## SECONDARY FAN AND POLYTOPE

- THM.** (Gelfand, Kapranov, and Zelevinsky) For  $P$  in general position in  $\mathbb{R}^d$ ,
- $\Sigma\mathbb{P}(P)$  has dimension  $|P| - d - 1$ ,
  - $\Sigma\mathcal{F}(P)$  is the inner normal fan of  $\Sigma\mathbb{P}(P)$ ,
  - The face lattice of  $\Sigma\mathbb{P}(P)$  is isomorphic to the regular subdivisions lattice of  $P$ .

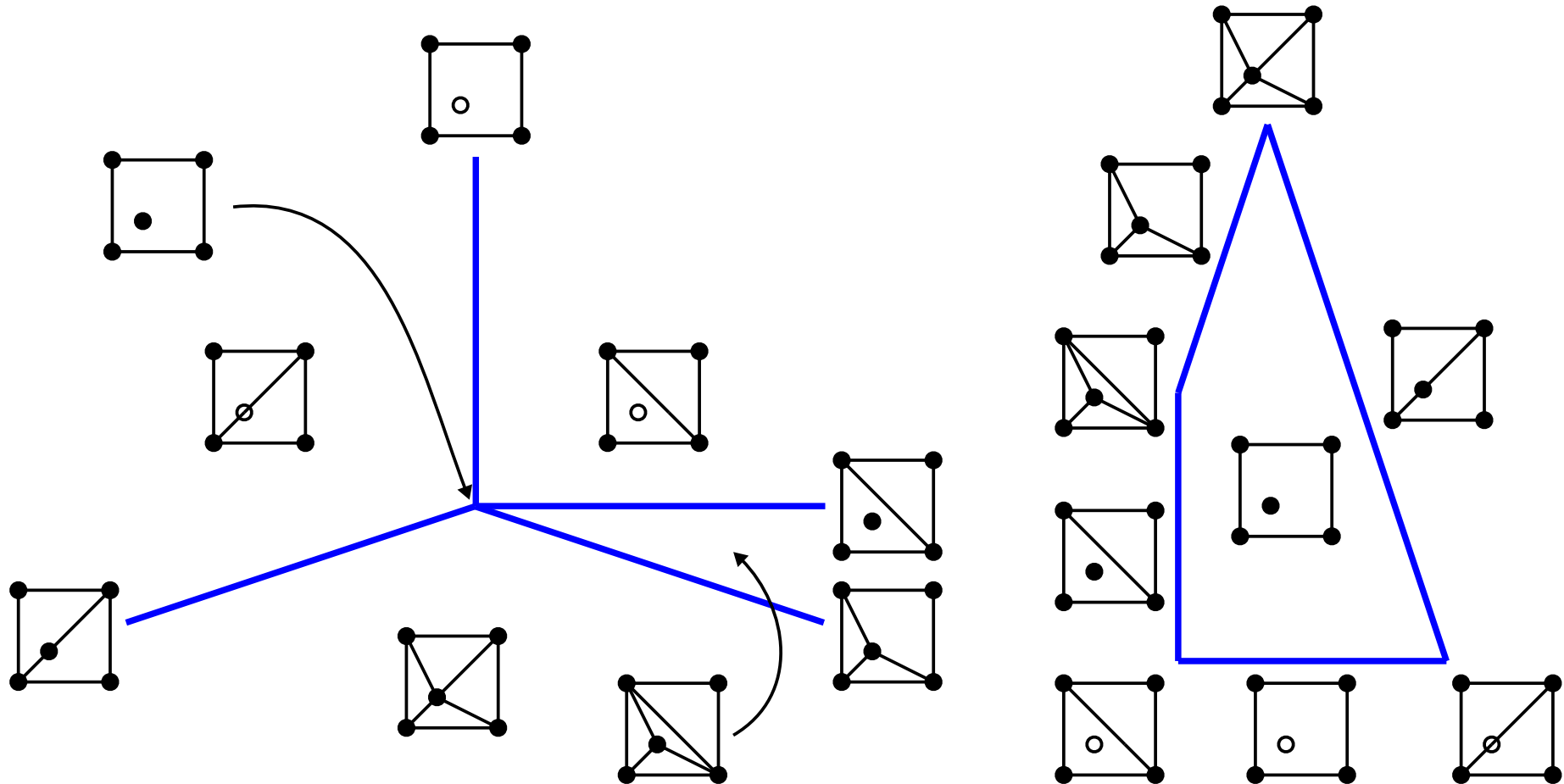

## SECONDARY FAN AND POLYTOPE

- THM.** (Gelfand, Kapranov, and Zelevinsky) For  $\mathbf{P}$  in general position in  $\mathbb{R}^d$ ,
- $\Sigma\mathbb{P}(\mathbf{P})$  has dimension  $|\mathbf{P}| - d - 1$ ,
  - $\Sigma\mathcal{F}(\mathbf{P})$  is the inner normal fan of  $\Sigma\mathbb{P}(\mathbf{P})$ ,
  - The face lattice of  $\Sigma\mathbb{P}(\mathbf{P})$  is isomorphic to the regular subdivisions lattice of  $\mathbf{P}$ .

proof: lower bound on  $\dim(\Sigma\mathbb{P}(\mathbf{P}))$  by induction on  $|\mathbf{P}|$ :

- when  $|\mathbf{P}| = 3$ ,  $\Sigma\mathbb{P}(\mathbf{P})$  is a single point,
- for  $|\mathbf{P}| \geq 4$  and any  $\mathbf{p} \in \mathbf{P}$ ,  $\Sigma\mathbb{P}(\mathbf{P} \setminus \mathbf{p}) = \Sigma\mathbb{P}(\mathbf{P}) \cap \{\mathbf{x} \in \mathbb{R}^P \mid x_{\mathbf{p}} = \alpha\}$  where

$$\alpha = \begin{cases} 0 & \text{if } \mathbf{p} \text{ inside } \text{conv}(\mathbf{P}), \\ \text{vol}(\text{conv}(\mathbf{P})) - \text{vol}(\text{conv}(\mathbf{P} \setminus \mathbf{p})) & \text{if } \mathbf{p} \text{ on the boundary of } \text{conv}(\mathbf{P}). \end{cases}$$

## SECONDARY FAN AND POLYTOPE

**THM.** (Gelfand, Kapranov, and Zelevinsky) For  $\mathbf{P}$  in general position in  $\mathbb{R}^d$ ,

- $\Sigma\mathbb{P}(\mathbf{P})$  has dimension  $|\mathbf{P}| - d - 1$ ,
- $\Sigma\mathcal{F}(\mathbf{P})$  is the inner normal fan of  $\Sigma\mathbb{P}(\mathbf{P})$ ,
- The face lattice of  $\Sigma\mathbb{P}(\mathbf{P})$  is isomorphic to the regular subdivisions lattice of  $\mathbf{P}$ .

proof: lower bound on  $\dim(\Sigma\mathbb{P}(\mathbf{P}))$  by induction on  $|\mathbf{P}|$ :

- when  $|\mathbf{P}| = 3$ ,  $\Sigma\mathbb{P}(\mathbf{P})$  is a single point,
- for  $|\mathbf{P}| \geq 4$  and any  $\mathbf{p} \in \mathbf{P}$ ,  $\Sigma\mathbb{P}(\mathbf{P} \setminus \mathbf{p}) = \Sigma\mathbb{P}(\mathbf{P}) \cap \{x \in \mathbb{R}^P \mid x_{\mathbf{p}} = \alpha\}$  where

$$\alpha = \begin{cases} 0 & \text{if } \mathbf{p} \text{ inside } \text{conv}(\mathbf{P}), \\ \text{vol}(\text{conv}(\mathbf{P})) - \text{vol}(\text{conv}(\mathbf{P} \setminus \mathbf{p})) & \text{if } \mathbf{p} \text{ on the boundary of } \text{conv}(\mathbf{P}). \end{cases}$$

upper bound on  $\dim(\Sigma\mathbb{P}(\mathbf{P}))$  from the volume and center of mass of  $\text{conv}(\mathbf{P})$ :

$$\text{vol}(\mathbf{P}) = \sum_{\Delta \in \mathcal{T}} \text{vol}(\Delta) = \sum_{\Delta \in \mathcal{T}} \sum_{\mathbf{p} \in \Delta} \frac{\text{vol}(\Delta)}{d+1} = \frac{1}{d+1} \sum_{\mathbf{p} \in \mathbf{P}} \sum_{\mathbf{p} \in \Delta \in \mathcal{T}} \text{vol}(\Delta) = \frac{1}{d+1} \sum_{\mathbf{p} \in \mathbf{P}} \Phi(\mathcal{T})_{\mathbf{p}}.$$

$$\text{vol}(\mathbf{P}) \cdot \text{cm}(\mathbf{P}) = \sum_{\Delta \in \mathcal{T}} \text{vol}(\Delta) \cdot \text{cm}(\Delta) = \sum_{\Delta \in \mathcal{T}} \text{vol}(\Delta) \cdot \left( \frac{1}{d+1} \sum_{\mathbf{p} \in \Delta} \mathbf{p} \right) = \frac{1}{d+1} \sum_{\mathbf{p} \in \mathbf{P}} \Phi(\mathcal{T})_{\mathbf{p}} \cdot \mathbf{p}.$$



## SECONDARY FAN AND POLYTOPE

**THM.** (Gelfand, Kapranov, and Zelevinsky) For  $P$  in general position in  $\mathbb{R}^d$ ,

- $\Sigma\mathbb{P}(P)$  has dimension  $|P| - d - 1$ ,
- $\Sigma\mathcal{F}(P)$  is the inner normal fan of  $\Sigma\mathbb{P}(P)$ ,
- The face lattice of  $\Sigma\mathbb{P}(P)$  is isomorphic to the regular subdivisions lattice of  $P$ .

proof:  $\mathcal{T}$  triangulation of  $P$  and a height vector  $\mathbf{h} \in \mathbb{R}^P$ .

$f_{\mathcal{T},\mathbf{h}} : \text{conv}(P) \rightarrow \mathbb{R}$  = piecewise linear map on the simplices of  $\mathcal{T}$  such that  $f_{\mathcal{T},\mathbf{h}}(\mathbf{p}) = \mathbf{h}_p$ .

Then the volume below the hypersurface defined by  $f_{\mathcal{T},\mathbf{h}}$  is

$$\begin{aligned} \int_{\text{conv}(P)} f_{\mathcal{T},\omega}(\mathbf{x}) d\mathbf{x} &= \sum_{\Delta \in \mathcal{T}} \int_{\Delta} f_{\mathcal{T},\omega}(\mathbf{x}) d\mathbf{x} = \sum_{\Delta \in \mathcal{T}} \frac{\text{vol}(\Delta)}{d+1} \sum_{p \in \Delta} \mathbf{h}_p \\ &= \frac{1}{d+1} \sum_{p \in P} \mathbf{h}_p \cdot \sum_{p \in \Delta \in \mathcal{T}} \text{vol}(\Delta) = \frac{\langle \Phi(\mathcal{T}) \mid \mathbf{h} \rangle}{3}. \end{aligned}$$

## SECONDARY FAN AND POLYTOPE

**THM.** (Gelfand, Kapranov, and Zelevinsky) For  $P$  in general position in  $\mathbb{R}^d$ ,

- $\Sigma\mathbb{P}(P)$  has dimension  $|P| - d - 1$ ,
- $\Sigma\mathcal{F}(P)$  is the inner normal fan of  $\Sigma\mathbb{P}(P)$ ,
- The face lattice of  $\Sigma\mathbb{P}(P)$  is isomorphic to the regular subdivisions lattice of  $P$ .

proof:  $\mathcal{T}$  triangulation of  $P$  and a height vector  $\mathbf{h} \in \mathbb{R}^P$ .

$f_{\mathcal{T},\mathbf{h}} : \text{conv}(P) \rightarrow \mathbb{R}$  = piecewise linear map on the simplices of  $\mathcal{T}$  such that  $f_{\mathcal{T},\mathbf{h}}(\mathbf{p}) = \mathbf{h}_p$ .

Then the volume below the hypersurface defined by  $f_{\mathcal{T},\mathbf{h}}$  is

$$\begin{aligned} \int_{\text{conv}(P)} f_{\mathcal{T},\omega}(\mathbf{x}) d\mathbf{x} &= \sum_{\Delta \in \mathcal{T}} \int_{\Delta} f_{\mathcal{T},\omega}(\mathbf{x}) d\mathbf{x} = \sum_{\Delta \in \mathcal{T}} \frac{\text{vol}(\Delta)}{d+1} \sum_{p \in \Delta} \mathbf{h}_p \\ &= \frac{1}{d+1} \sum_{p \in P} \mathbf{h}_p \cdot \sum_{p \in \Delta \in \mathcal{T}} \text{vol}(\Delta) = \frac{\langle \Phi(\mathcal{T}) \mid \mathbf{h} \rangle}{3}. \end{aligned}$$

Therefore, if  $\mathcal{T} = \mathcal{S}(P, \mathbf{h}) \neq \mathcal{T}'$  then

$$\langle \Phi(\mathcal{T}) \mid \mathbf{h} \rangle < \langle \Phi(\mathcal{T}') \mid \mathbf{h} \rangle.$$

In other words, the normal cone of  $\Phi(\mathcal{T})$  in  $\Sigma\mathbb{P}(P)$  is the secondary cone of  $\mathcal{T}$ .

## SECONDARY FAN AND POLYTOPE

- THM.** (Gelfand, Kapranov, and Zelevinsky) For  $P$  in general position in  $\mathbb{R}^d$ ,
- $\Sigma\mathbb{P}(P)$  has dimension  $|P| - d - 1$ ,
  - $\Sigma\mathcal{F}(P)$  is the inner normal fan of  $\Sigma\mathbb{P}(P)$ ,
  - The face lattice of  $\Sigma\mathbb{P}(P)$  is isomorphic to the regular subdivisions lattice of  $P$ .

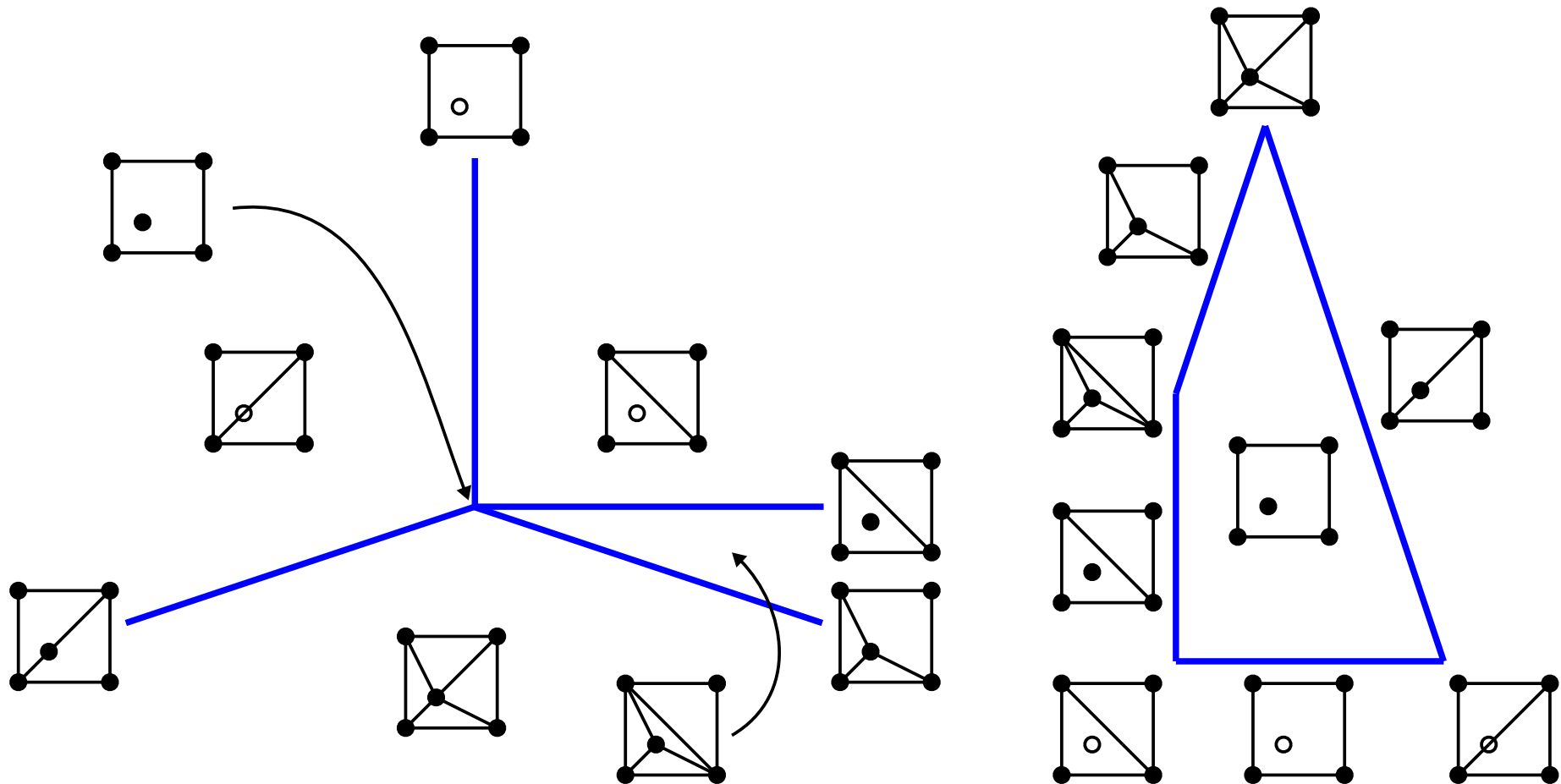

# SECONDARY FAN AND POLYTOPE

QU. Locate the volume vectors of the non-regular triangulations

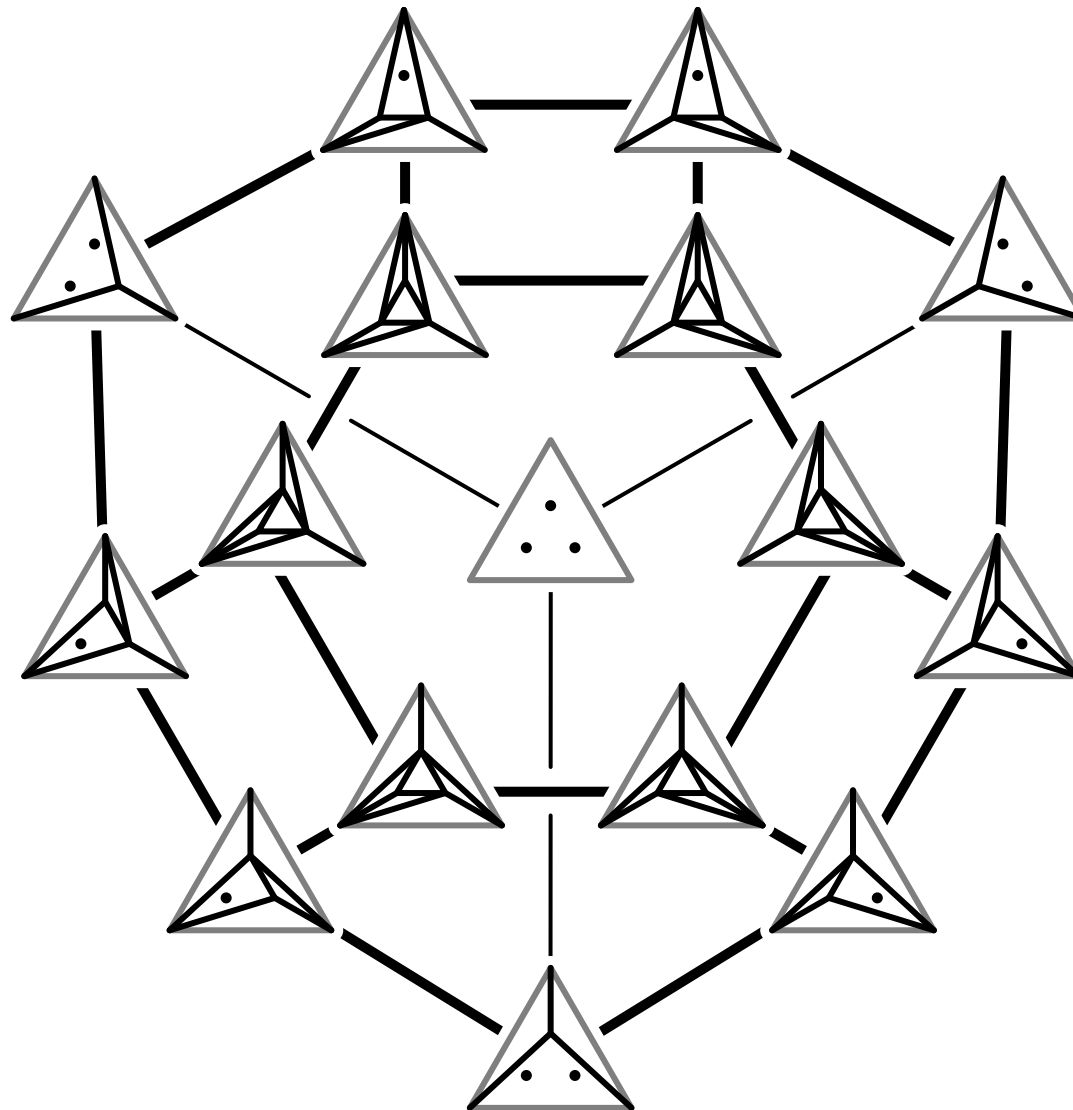
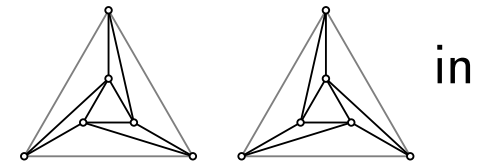

---

## SOME REFERENCES

---

## SOME REFERENCES

---

- Jesus A. De Loera, Jörg Rambau, and Francisco Santos.  
*Triangulations: Structures for Algorithms and Applications.*  
Vol. 25 of *Algorithms and Computation in Mathematics*. Springer Verlag, 2010.
- Günter M. Ziegler. *Lectures on polytopes.*  
Vol. 152 of *Graduate Texts in Mathematics*. Springer-Verlag, New York, 1995.